

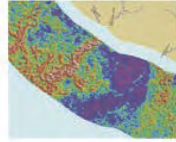

TTRL OFFSHORE IRON SANDS PROJECT

INTRODUCTION



INTRODUCTION

In 2016 Trans-Tasman Resources Limited (**TTR**) will lodge marine consent application with the Environmental Protection Authority (**EPA**) under the Exclusive Economic Zone and Continental Shelf (Environmental Effects) Act 2012 (**EEZ Act**) for the recovery of iron sand from the South Taranaki Bight. This new application follows a previous application by TTR in 2013 / 2014, which was declined by a Decision-Making Committee (**DMC**) appointed by the EPA.

As part of preparing its revised marine consent application, TTR is seeking to consult with key stakeholders and iwi regarding the iron sands project and to provide information on how potential environmental effects will be managed and monitored. In light of this, the purpose of this stakeholder engagement package is to provide information to key stakeholders on the iron sands project and the revised suite of environmental assessments that have been commissioned by TTR.

This stakeholder engagement package contains the following information:

1. An overview of the iron sands project, including the methodology that will be employed by TTR to recover iron sand from the seabed outside of the 12 nautical mile limit between Patea and Hawera;
2. An overview of the projected economic benefits of the project;
3. An overview of the additional science that has been commissioned by TTR with respect to the expected extent and density of the plume, including its effects on optics and primary production; and
4. A summary of other environmental assessments and where applicable, the findings of the peer reviewers engaged by the EPA for the previous marine consent application together with the results of any related expert witness conferencing held prior to the previous hearing.

TTR is seeking that key stakeholders review the information provided in the stakeholder engagement package to obtain an understanding of the project and its predicted environmental effects. TTR will arrange meetings with key stakeholders to address any questions regarding the operation of the iron sands project and the results of the additional scientific information that has been commissioned. These meetings will commence in October 2015.

TTR is able to provide stakeholders with copies of the draft environmental assessments referenced in the stakeholder engagement package. However, the circulation of these draft assessments to key stakeholders will be contingent on agreement between TTR and respective key stakeholders regarding the protection of TTR's intellectual property. This matter can be discussed at the forthcoming meetings.

A comprehensive summary of the various new work undertaken by international independent experts is contained in the following package. However, because the 'plume-related' effects of the proposal have been significantly refined as a result of this new work, a brief summary is provided, as follows:

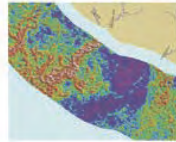

1. NEW SCIENTIFIC INFORMATION

The DMC that considered TTR's original application for marine consent noted the uncertainties around the scale of the predicted effects on the environment, particularly the assumptions with regards to the extent and density of the plume, the effects on primary productivity, and the scale of impacts on existing interests - specifically iwi and commercial fishing interests (EPA, 2014). In light of this, TTR has undertaken an extensive programme to supplement and update its modelling and assessment on the extent and density of the plume that will be generated during the recovery of iron sand.

The objective of the programme undertaken by TTR has been to provide additional, refined technical information about the extent and density of the sediment plume. To undertake this programme of work TTR has augmented local expertise by retaining world-leading experts in sediment modelling, optics and primary production from the United States of America and United Kingdom. An overview of the assessments undertaken by TTR's scientific team is provided in the attached stakeholder engagement package, and is summarised below.

1.1 Plume Modelling

The international experts retained by TTR have undertaken detailed peer reviews of the original models developed by NIWA, and also undertaken further testing on the re-deposition of sediment material in order to enable more accurate modelling of the extent and density of the plume. In particular, the peer review and testing by HR Wallingford Ltd (**HRW**) has allowed for more accurate modelling of the plume in relation to the following:

- Flocculation - the original plume model neglected flocculation, a mechanism whereby fine sediment combines into faster-sinking aggregate;
- Sediment settling rates - the extent to which the fine suspended sediment would settle to the bottom and be trapped in the matrix of discharged sand is predicted to occur to a greater extent than previously assumed; and
- Sediment re-suspension - the testing by HRW found that the shear stress required for re-suspension of freshly deposited material was in the range 0.2–0.3Pa rather than the 0.1Pa (minimum value), as originally assumed by NIWA.

The increased definition in the elements listed above on the predicted plume extent and density can be demonstrated by comparing the median near-surface results for the most inshore and offshore mining locations in the modelling done in 2014 to that done in 2015. This is demonstrated in Figures 1 to 4 below (noting in particular that the shading represents any modelled concentration that is above zero, irrespective of whether it is even discernible – the grey shading in the figures represents a concentration of less than 0.2 milligrams of sediment per litre of seawater. Note also that one teaspoon of this sediment weights around 15 grams, so the grey line represents about 1/75,000th of a teaspoon of sediment in a litre of seawater:

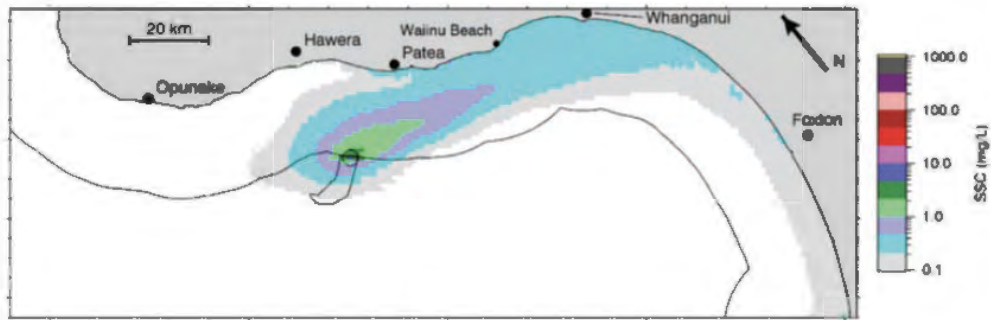
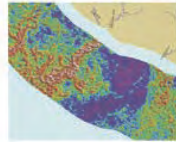

Figure 1 Inshore Sediment Release Median 2014

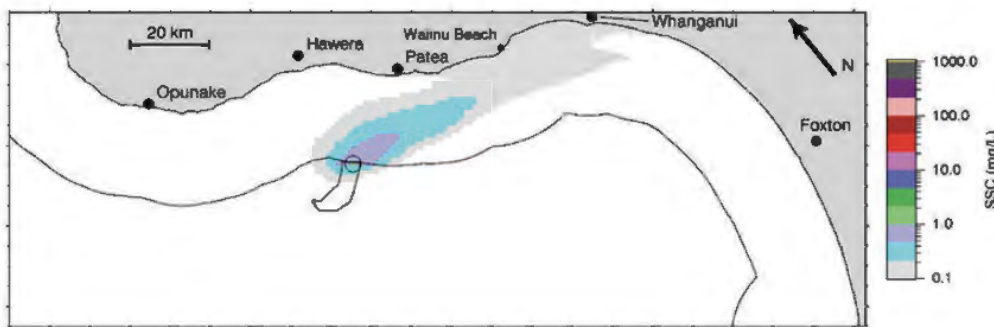

Figure 2 Inshore Sediment Release Median 2015

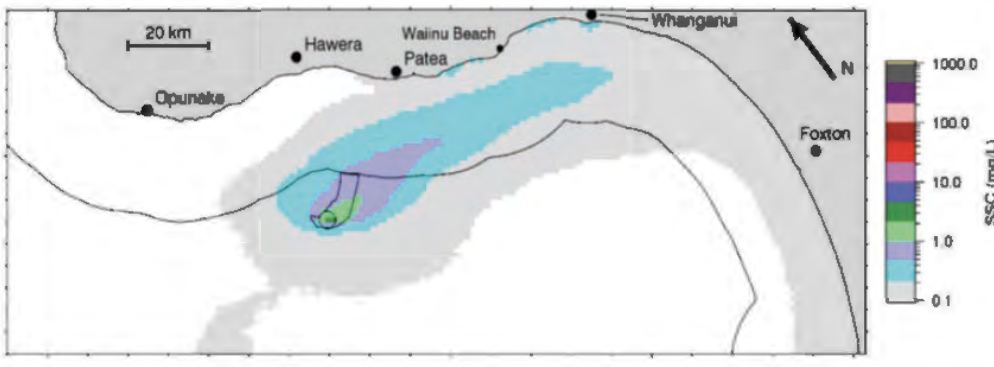

Figure 3 Offshore Sediment Release Median 2014

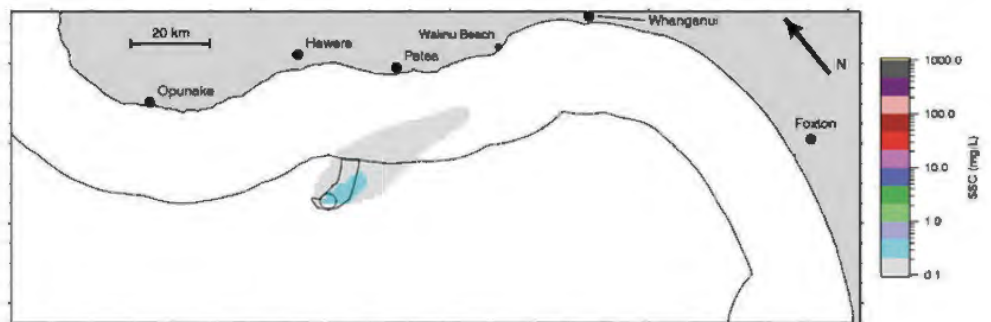

Figure 4 Offshore Sediment Release Median 2015

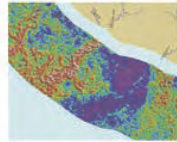

Figure 2 shows the extent of the plume is reduced in the 2015 model and the near surface, suspended source extends to the east-southeast. Between Patea and Whanganui the suspended concentrations are substantially less than naturally occurring background concentrations (100 times less). The highest surface concentrations occur at the source location and are approximately 1.45mg/l (median), or approximately 1/10,000th of a teaspoon per litre. Approximately 20km 'downstream' from the source location the surface concentrations reduce to around 0.35mg/l (median) or approximately 2/100,000th of a teaspoon per litre.

For the furthestmost offshore mining location within the mining area, Figure 4 shows the plume is located further offshore but follows a similar path to the east-southeast, but with the concentrations being significantly lower still.

1.2 Optics

With respect to the predicted changes to the optical properties in the South Taranaki Bight, the previous modelling by NIWA has been updated in response to the results of the new sediment transport modelling. The main conclusions of the optical modelling based on iron sand recovery at two different representative locations (Site A, which is located at the inner limit of the proposed operations, close to the 12 nautical mile limit and Site B, which is located at the outer extent of the proposed operation) are:

- The optical effects of the iron sand recovery operations are likely to cease very quickly after the operations cease;
- There is substantial natural variability in optical properties in the modelled area, with greater turbidity at the coast;
- The optical effects of the plume decrease away from the iron sand recovery operations;
- The optical effects of the plume will be greater in the offshore area than in the nearshore area, with effects being minimal close to the coast (i.e. within approximately 5km of the coast);
- Average light in the water column averaged over the domain of the sediment model (an area of 13,000km²) is predicted to be reduced by only a small amount - approximately 1.9% based on ore recovery at Site A and 1.6% based on ore recovery at Site B; and
- The total amount of light received by the seabed in the domain of the sediment model is predicted to reduce by 23% (Site A) and 16% (Site B), and this reduction will occur primarily east of the proposed iron sand recovery operation.

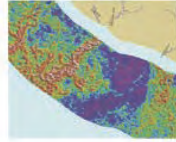

1.3 Primary Productivity

The potential effects of the project on primary productivity have now been recalculated as follows:

- Light in the water column, integrated over the modelled area and averaged by year, is predicted to reduce 1.9% at Site A and by 1.6% at Site B;
- The total amount of light at the seabed, over the whole modelled area averaged over a year, is predicted to reduce by 24% at Site A and by 15% at site B;
- The project will reduce energy flow to the seabed ecosystem, averaged over the modelled area, by 5.8% at Site A and by 4.1% at Site B;
- The project will reduce water column primary production, averaged over the modelled area, by 1% at Site A and 0.8% at Site B; and
- The project will reduce benthic primary production, averaged over the modelled area, by 19% at Site A and 13% at Site B.

The analyses of the field data, coupled with modelling of the character of the sediment plume from iron sand recovery operations, its trajectory and duration, and its optical effects, and the analyses of these effects on primary production in the modelled area strongly support the conclusion that the overall effects of iron sand recovery operations on short-lived organisms (i.e. those living less than a year or two) will be indistinguishable within natural oceanographic variability. Effects at local scale proximal to the iron sand recovery operations will be limited to decreases in microphytobenthos production and organic carbon availability to benthic consumers. This may exceed natural variability and may propagate locally to organisms that feed primarily on microphytobenthos and in turn to their predators.

1.4 Marine Ecological Effects

TTR has also commissioned NIWA to provide an assessment of the effects of the proposed iron sand recovery activities on key zooplankton, fish, seabird and marine mammal species - taking into account the spatial and temporal scales relevant to different components of the ecosystem. This assessment has also taken the latest sediment transport and optical modelling results into consideration.

The assessment of the spatial and foraging ecology of the key fauna occurring in the South Taranaki Bight has identified that the environmental effects will be negligible for all zooplankton, seabird, and marine mammal species, and most fish species. For coastal kaimoana species, the proposed iron sand recovery activities should not add significantly to the levels of suspended sediments currently experienced inshore in frequently turbid waters.

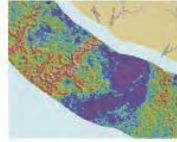

The assessment did identify that eagle ray may be affected by iron sand recovery activities. Although the area potentially impacted by iron sand recovery comprises less than 1% of the area of distribution of eagle ray in Fisheries Management Area 8, approximately 8% of its core area of distribution (>50% occurrence) overlaps with the area where suspended sediment concentrations will be elevated above 3mg/l. Using this threshold, a minor to moderate proportion of the eagle ray stock could be affected by mining through displacement of fish, or decrease in prey abundance or availability.

During summer and autumn eagle rays tend to concentrate inshore in water less than 10m deep where background suspended sediment concentrations may naturally reach over 100mg/l. This means that eagle rays may be tolerant to significantly higher suspended sediment concentrations than the threshold of 3mg/l used to assess the impact of the proposed iron sand recovery activities.

This is a substantially reduced level of effect than may have been inferred from the previous application, and in TTR's opinion should give stakeholders and iwi considerable confidence that this project can proceed in an environmentally appropriate and sustainable manner.

2. OVERALL SUMMARY

The new modelling and scientific assessments undertaken by internationally recognised experts fundamentally recasts understanding of the scale and extent of the potential environmental effects associated with the recovery of iron sand from the seabed of the South Taranaki Bight. In this regard, it can be demonstrated that the plume associated with iron sand recovery will produce changes in sediment concentrations that are within the range of natural variability at the scale of the modelled domain or the wider South Taranaki Bight and will not result in any ecologically significant adverse effects on primary productivity or fixed carbon flux to marine ecosystems at the large scale. Significant localised effects may occur but these would be patchy and episodic in nature and the ecosystem would recover once the recovery activities progress or stop.

TTR looks forward to discussing the project and answering any questions regarding the new modelling and scientific assessments with key stakeholders. As already, a representative of TTR will make contact with you in the near future to arrange a convenient time to commence these discussions.



TTRL OFFSHORE IRON SANDS PROJECT

PROJECT DESCRIPTION

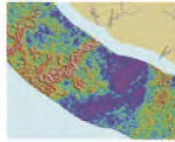

1. INTRODUCTION

Trans-Tasman Resources Limited (TTR) is a privately-owned New Zealand registered company with its headquarters in Wellington. The company was established in 2007 to explore, assess and develop offshore iron sand deposits within New Zealand. It is committed to using world best practice to both maximise the efficiency of the sediment recovery and processing activities, while at the same time minimising any environmental effects.

2. THE PROJECT

TTR intends to seek marine consent from the Environmental Protection Authority (EPA) under the Exclusive Economic Zone and Continental Shelf (Environmental Effects) Act 2012 (EEZ Act) for the recovery of iron sand from an area of 65.76 square kilometres located outside the 12 nautical mile limit between Patea and Hawera (Figure 1).

TTR holds exclusive mineral rights over this area in accordance with Mining Permit 55581, which was granted by New Zealand Petroleum and Minerals in May 2014. The mining permit provides TTR with exclusive rights, under the Crown Minerals Act 1991 to recover iron sand from the area for 20 years.

TTR will be seeking all necessary marine consents under section 20 of the EEZ Act in order to authorise the iron sand recovery operation. The extent of the iron sand resource within the recovery area is shallow (generally no more than 11m deep below the seabed) but widely dispersed. The area provides sufficient space for project operations (including extraction, de-ored sediment re-deposition operations), anchor handling and potential grade control drilling.

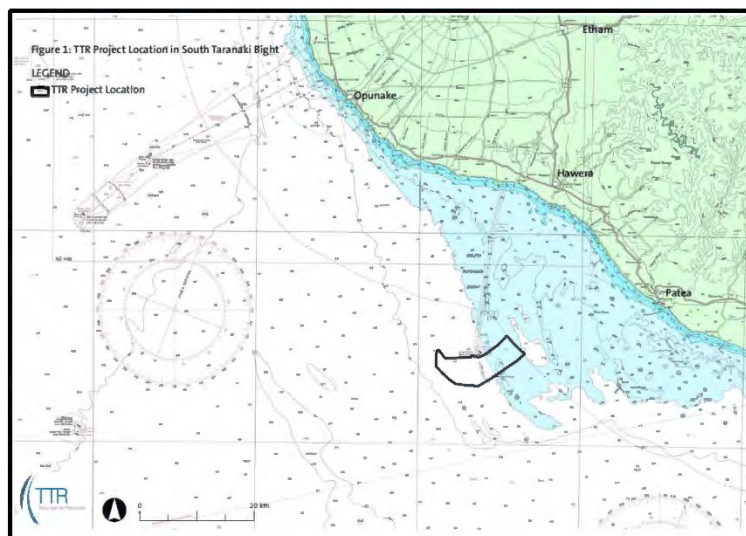
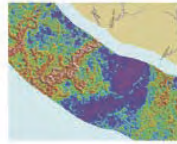

Figure 1: TTR Marine Consent Location in the South Taranaki Bight



3. PROJECT SCALE AND DURATION

The proposed operations are designed to recover, produce and export up to 5 million tonnes of iron sand concentrate per annum. To achieve this production the sediment extraction equipment will have the capacity to recover and process up to 8,000 tonnes of sediment per hour.

Operations will occur 24 hours a day, 7 days per week, with an estimated 28% downtime due to inclement weather, vessel operations, plant and equipment maintenance and anchor relocation.

TTR intends to apply for a marine consent with duration of 20 years in accordance with section 73 of the EEZ Act. This duration takes into consideration the time required to construct and commission a purpose built Integrated Extraction Vessel, as well as allowance for post operational monitoring.

4. IRON SANDS MINERAL RESOURCE

Iron sands generally form onshore beach and dune deposits, however extensive deposits also exist offshore of the west coast of the North Island. These deposits occur along 480km of coastline from Kaipara Harbour in the north to Wanganui in the south.

The iron sands targeted by TTR comprise a black, heavy, magnetic iron ore that originated as crystals in volcanic rocks largely derived from Mount Taranaki. Over thousands of years these rocks have been washed down by rivers, transported along the coast by shallow-marine long-shore currents, and subsequently concentrated offshore by historical wave and wind action into offshore remnant beach and dune lag deposits located 22-36km offshore in water depths of 20-42 metres.

5. SEDIMENT RECOVERY OPERATIONS

The iron sand recovery operations will involve five special purpose vessels designed to recover, process and handle the iron sand sediment. These vessels include the Integrated Mining Vessel (IMV), a purpose-built vessel that recovers, processes and transfers the iron sand concentrate; the Floating Storage and Offloading (FSO) vessels; an Anchor Handling Vessel (AHT); a Geotechnical Support Vessel and a re-fuelling vessel.

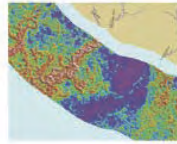
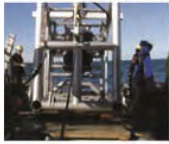

- Station keeping and tracking during the sediment extraction operation;
- Supporting and housing the extraction system, launch and recovery system, vertical transport system and auxiliary services;
- Supporting and housing a processing plant;
- Buffering and stockpiling slurries and concentrates to allow for a continuous process;
- Continuous offloading de-ored sediment;
- Periodically offloading concentrate to a dedicated transfer vessel;
- Housing a power generation plant capable of supplying sufficient power to drive the extraction system, launch and recovery system, vertical transport system, processing plant, desalination plant, product transfer and auxiliary services;
- Providing sufficient office space and accommodation for the maritime, extraction and processing system operational staff complements; and
- Supporting helideck(s) in order to facilitate personnel transfer.

The IMV will provide the platform for the following operational modules:

- Extraction (Crawler) Module;
- Beneficiation Module;
 - Screening;
 - Magnetic Separation; and
 - Grinding.
- Power Generation Module; and
- Desalination Plant.

The IMV will be fitted with a 4 point, dynamic positioned winch mooring system, allowing the IMV to be continually winched on a pre-determined extraction and associated deposition pattern. The operational procedure requires the IMV to follow the extraction crawler at an average rate of 70m/hr. At this speed a 900m x 600m block will typically be worked in around 30 days. The mooring configuration has been designed to allow access by transfer vessels without interrupting the extraction or beneficiation processes.

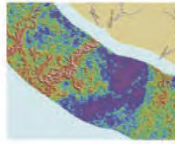

Figure 3: The Integrated Extraction and Processing Vessel.

Iron Sand Recovery

A submerged remote controlled crawler will be launched and recovered from the stern of the IMV, which will recover iron sand from the seabed in a single pass. The crawler extracts the seafloor sediment to a predetermined depth (up to 11m) and takes the full vertical face of the extractable sediment.

The crawler is operated remotely by an operator on the IMV via an umbilical which includes a power cable, various hydraulic hoses, and a 900mm diameter delivery hose. The key features of the crawler operation are as follows:

- IMV Connection: The crawler is lowered to the seabed and raised to the IMV via a retractable deck and lift mechanism from the stern of the IMV;
- Electrical: Power demand of the crawler is up to 5MW, with supply via an umbilical. A submersible electric motor will provide power for driving the main slurry pump. The dredge pump will be directly coupled to the electric motor and like all submerged mechanical, electrical and electronic equipment, will be pressure compensated to prevent water entering the housing;
- Manoeuvring: Manoeuvring of the crawler will be achieved via two hydraulic driven tracks attached to the chassis of the machine;

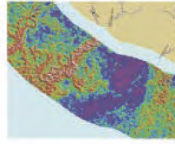

- Hydraulic System: The hydraulic design will use best international practice. Flexible hoses with stainless steel fittings will be used for all connections between the valve tanks, intermediate couplings and hydraulic cylinders. Hydraulic oil will be stored on the IMV with connection via the umbilical. Marine biodegradable hydraulic oil will be used to minimise the risk of adverse environmental effects should a spill occur. Hydraulic oil pressure in all feed lines will be closely monitored with automatic shut-off equipment in the event of pressure loss; and
- Sonar Imaging: The crawler will employ imaging sonar. Utilising an array of transducers, the crawler will typically provide the operator with 120 degree constant field of vision of the underwater scene ahead.

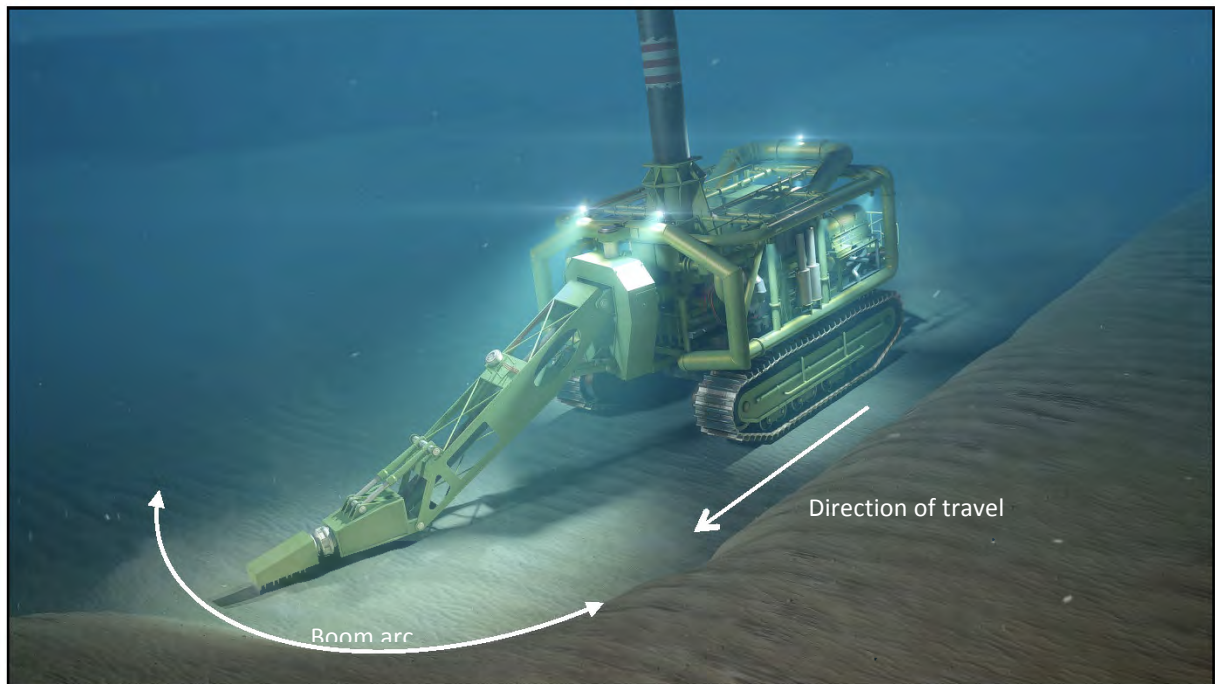
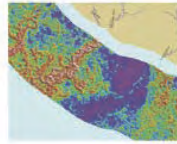
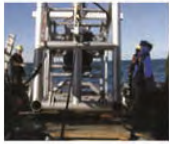

Figure 4: Crawler Operation



Sediment Processing

The production of the iron sand concentrate from the recovered sediment only involves physical separation techniques and hence no chemicals are utilised. The general processing description is as follows:

- Initial Screening: The first process for the run of recovered sediment from the crawler is processed through screens, which is done to reject particles larger than 3mm. Sediment less than 3mm will then be fed under gravity to water-agitated storage tanks directly below the screen area for further processing. Oversize material will be fed via a chute to de-watering and de-ored sand handling areas, and then re-deposited on the seabed;
- First Stage Magnetic Separation: Sediment less than 3mm from vibrating screens will be pumped from the agitated storage tanks to the first stage of magnetic separation units (Medium Intensity Magnetic Separators or “MIMS”). This step will capture magnetic particles whilst rejecting the majority of the de-ored sand;
- Second Stage Magnetic Separation: Magnetic sediment from the first stage magnetic separation is passed through another set of magnetic separating units (Lower Intensity Magnetic Separators or “LIMS”). This refines the magnetic sediment whilst rejecting further non-magnetic material;
- Size Classification: Sediment from the second stage magnetic separation is screened into coarser sediment and finer sediment. This separation is done by a series of specialised stacked screening units, capable of dealing with the large amounts of fine sediment;
- Grinding: The coarser oversize sediment from size classification process is pumped to a grinding mill for the sediment to be ground into a smaller sized particle. This is done to liberate magnetic particles and improve the overall recovery of the iron sand;
- Final Magnetic Separation: The final magnetic separation will comprise further LIMS units to produce the final iron sand concentrate;

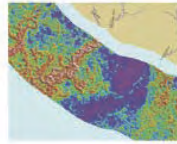
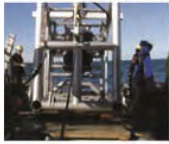

- Final Concentrate Handling: De-watered concentrate from the final magnetic separation process will be stored ready for transfer to the FSO. The FSO will connect to the IMV via a floating slurry pipe line and the de-watered concentrate on the IMV will be mixed with produced freshwater to form a slurry of 50% solids by weight. Freshwater is used to wash the concentrate to reduce the chloride level of the product. Once the slurry has been pumped to the FSO it will be filtered to a low moisture content using four hyperbaric pressure filters. Filtrate freshwater will be discharged to sea from the FSO; and

- Handling of De-Ored Sand: De-ored sand will be de-watered before disposal. Coarse and fine de-ored sand will be de-watered separately before being discharged under gravity via the de-ored sand deposition pipe. The deposition pipe will be controlled using sonar such that the discharge occurs at a constant height from the seabed. The discharge pipe will be controlled to maintain a height of 4m above the deposited de-ored sediment, this is to ensure the release of sediment into the water column is minimised.

IMV Re-Positioning

The IMV will deploy 4 standard Stevpris-type anchors, each attached directly to the IMV by 90mm diameter, tensioned steel cables and a 50-100m length of anchor chain. The anchoring system will be designed to accommodate the dynamic loads of the IMV in the prevailing weather conditions in the South Taranaki Bight.

The IMV will use a winching system on the anchor lines to continuously re-locate itself relative to the location of the crawler, which will be working 600m x 900m blocks in a predetermined sequence (see Figure 5). The IMV will follow the crawler at a typical advance rate of around 70 metres per hour.

The IMV will winch itself along in tandem with the crawler as the recovery of iron sands occurs, relying on the four anchors, which will be positioned by the Tug. The IMV will also utilise a dynamic positioning system for supplementary control.

When transiting to the next extraction block, the AHT will assist in moving anchors to new positions.

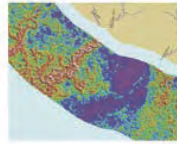
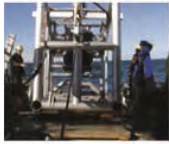

5.2 Extraction Sequencing

The recovery of sediment from the seabed will be undertaken in a planned and considered manner, with a number of factors combining to ensure maximal operational efficiency while minimising effects on the environment. Prior to recovery operations occurring, close spaced grade control drilling will be undertaken in order to understand and document any variability in the sampling and the recoverable sediment, By understanding the variability of the sediment sizes and the chemistry of the sediment, the extraction operation can be “fine-tuned” on a site-specific basis to ensure optimal performance.

The IMV will be orientated on a pre-determined section or block of the seabed. These blocks are 900m by 600m and are oriented to ensure maximum stability of the IMV with the prevailing metocean conditions. This block size is determined by the anchor mooring configuration, in that this is the maximum distance the anchor can be spread before anchor relocation would be required. Once a block is extracted the IMV and the mooring anchors are relocated into a position adjacent to the previously used extraction block so de-ored sediment can be backfilled into the previously worked area.

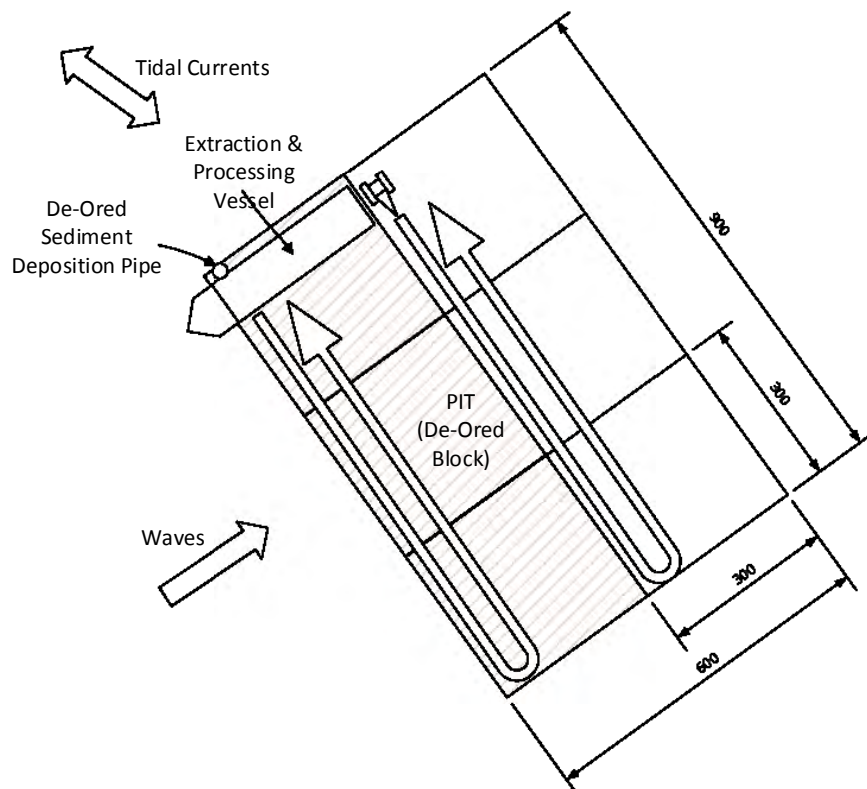
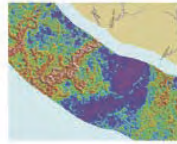
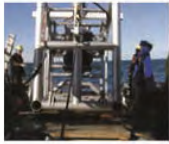
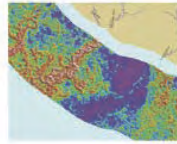
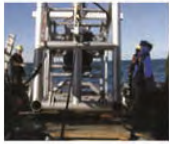

Figure 5: Extraction Sequencing



5.3 Associated Operational Activities

- Grade Control Drilling and Geophysical Surveying: These operations will be undertaken by an expert geotechnical team which will be set up to undertake various pre and post extraction activities utilising specialised equipment;
- Environmental Monitoring Activities: These operations will also be undertaken by the geotechnical team which will have the equipment to undertake continuous surveys such as sidescan sonar, multi-beam and the checking and servicing of environmental monitoring devices;
- Anchor Handling Tug Operations: The AHT will be used to assist the IMV when re-positioning of the mooring anchors is required, as well as general resupply to the vessels, refuelling support and general support;
- Trans-shipment Activities (Ore transfer): FSO vessel will be used to transfer the iron sand concentrate from the IMV, dewater and store, and then transfer onto the larger iron sand ore carrier vessels. Trans-shipment activities will occur within the South Taranaki Bight as close as practicable to the extraction operations. In times of adverse weather events the trans-shipment of dry ore onto the ore carriers will take place in Admiralty Bay at the head of Pelorus Sound;
- Fuel Transfer Operations: These are to be undertaken by a dedicated bunkering vessel which will resupply the offshore vessel with heavy fuel oil;
- Re-Supply Operations: Will be undertaken by the AHT vessel; and
- Crew Transfer Operation: These activities will be undertaken by helicopter, similar to servicing arrangements for the offshore petroleum industry in the Taranaki Region.



6. CONCLUDING STATEMENT

TTR intends to seek marine consent from the Environmental Protection Authority (EPA) under the Exclusive Economic Zone and Continental Shelf (Environmental Effects) Act 2012 (EEZ Act) for the recovery of iron sand from an area of 65.76 square kilometres located outside the 12 nautical mile limit between Patea and Hawera.

TTR is committed to using world best practice to both maximise the efficiency of the sediment extraction and processing activities, while at the same time minimising any environmental effects. The company has undertaken a comprehensive design of the project, as described above, in order that these two objectives will be achieved.



TTRL OFFSHORE IRON SANDS PROJECT

**SUMMARIES OF
ENVIRONMENTAL ASSESSMENTS
AND ASSOCIATED PEER REVIEWS**

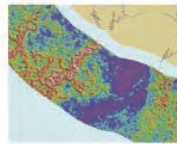
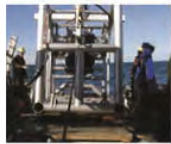

INTRODUCTION..... 6

AIR DISCHARGES 7

1.1 TTR ASSESSMENT: AIR DISPERSION MODELLING STUDY T&T REFERENCE 29303..... 7

 1.1.1 EPA Review Findings..... 8

 1.1.2 Joint Expert Conferencing Results..... 8

ARCHAEOLOGICAL..... 9

1.2 TTR ASSESSMENT: ARCHAEOLOGICAL ASSESSMENT. CLOUGH & ASSOCIATES LTD. 9

 1.2.1 EPA Review Findings..... 9

 1.2.2 Joint Expert Conferencing Results..... 9

BASELINE ENVIRONMENTAL REPORT10

1.3 TTR REPORT: SOUTH TARANAKI BIGHT FACTUAL BASELINE ENVIRONMENT REPORT (MACDIARMID ET AL. 2011) 10

 1.3.1 EPA Review Findings..... 12

 1.3.2 Joint Expert Conferencing Results..... 12

BATHYMETRY SIDE-SCAN & SEISMIC REPORTS13

1.4 TTR REPORT: MULTIBEAM SURVEY IN SOUTHERN TARANAKI BIGHT (PALLENTIN ET AL. 2013) 13

 1.4.1 EPA Review Findings..... 13

 1.4.2 Joint Expert Conferencing Results..... 13

1.5 TTR REPORT: HIGH-RESOLUTION BOOMER SURVEY IN SOUTH TARANAKI BIGHT 2ND SURVEY (WOELZ AND WILCOX 2013)13

 1.5.1 EPA Review Findings..... 13

 1.5.2 Joint Expert Conferencing Results..... 14

1.6 TTR REPORT: SIDESCAN SURVEY OF SOUTH TARANAKI BIGHT SEDIMENTS (GERRING ET AL. 2012) 14

 1.6.1 EPA Review Findings..... 14

 1.6.2 Joint Expert Conferencing Results..... 14

BENTHIC STUDIES.....15

1.7 TTR REPORT: BENTHIC HABITATS, MACROBENTHOS AND SURFICIAL SEDIMENTS OF THE NEARSHORE SOUTH TARANAKI BIGHT (ANDERSON ET AL. 2013)..... 15

1.8 TTR REPORT: BENTHIC FLORA AND FAUNA OF THE PATEA SHOALS REGION, SOUTH TARANAKI BIGHT (BEAUMONT ET AL. 2013)16

 1.8.1 EPA Review Findings..... 17

 1.8.2 Joint Expert Conferencing Results..... 17

CETACEAN SURVEY AND HABITAT MODELLING20

1.9 TTR REPORT: HABITAT MODELS OF SOUTHERN RIGHT WHALES, HECTOR'S DOLPHIN, AND KILLER WHALES IN NEW ZEALAND (TORRES ET AL. 2013) 20

1.10 TTR REPORT: CETACEAN MONITORING REPORT (MARTIN CRAWTHORN ASSOCIATES 2013) 20

 1.10.1 EPA Review Findings..... 21

 1.10.2 Joint Expert Conferencing Results..... 21

COASTAL STABILITY.....23

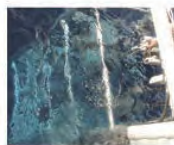
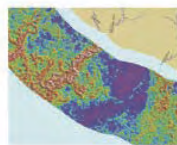

1.11 TTR REPORT: COASTAL STABILITY IN THE SOUTH TARANAKI BIGHT - PHASE 2 POTENTIAL EFFECTS OF OFFSHORE SAND EXTRACTION ON PHYSICAL DRIVERS AND COASTAL STABILITY (HUME ET AL. 2013) 23

 1.11.1 EPA Review Findings..... 23

 1.11.2 Joint Expert Conferencing Results..... 24

EFFECT OF SHIPS LIGHTS25

1.12 TTR REPORT: EFFECTS OF SHIPS LIGHTS ON FISH, SQUID AND SEABIRDS (THOMPSON 2013) 25

 1.12.1 EPA Review Findings..... 25

 1.12.2 Joint Expert Conferencing Results..... 26

ZOOPLANKTON26

1.13 TTR REPORT: ZOOPLANKTON AND THE PROCESSES SUPPORTING THEM IN GREATER WESTERN COOK STRAIT (BRADFORD-GRIEVE AND STEVENS 2013) 26

 1.13.1 EPA Review Findings..... 27

 1.13.2 Joint Expert Conferencing Results..... 27

SEABIRDS28

1.14 TTR REPORT: SEABIRDS OF THE SOUTH TARANAKI BIGHT (THOMPSON 2013) 28

 1.14.1 EPA Review Findings..... 28

 1.14.2 Joint Expert Conferencing Results..... 28

FISH IN THE SOUTH TARANAKI BIGHT29

1.15 TTR REPORT: SOUTH TARANAKI BIGHT FISH AND FISHERIES (MACDIARMID ET AL. 2013) 29

 1.15.1 EPA Review Findings..... 30

 1.15.2 Joint Expert Conferencing Results..... 31

COMMERCIAL FISHING32

1.16 TTR REPORT: ASSESSMENT OF POTENTIAL IMPACTS ON COMMERCIAL FISHING (FATHOM CONSULTING LTD. 2013)..... 32

 1.16.1 EPA Review Findings..... 33

 1.16.2 Joint Expert Conferencing Results..... 33

GEOLOGY34

1.17 TTR REPORT: GEOLOGICAL DESKTOP SUMMARY ACTIVE PERMIT AREAS 50753 (55581), 54068 AND 54272, SOUTH TARANAKI BIGHT (ORPIN 2013) 34

 1.17.1 EPA Review Findings..... 34

NAVIGATIONAL35

1.18 TTR REPORT: SOUTH TARANAKI BIGHT MARINE TRAFFIC STUDY (MARICO MARINE LTD. 2013) 35

 1.18.1 EPA Review Findings..... 36

1.19 TTR REPORT: REPORT ON THE MARITIME AND NAVIGATIONAL IMPACTS OF THE PROJECT (BARLOW 2013) 36

 1.19.1 EPA Review Findings..... 37

 1.19.2 Joint Expert Conferencing Results..... 37

NOISE39

1.20 TTR REPORT: ASSESSMENT OF NOISE EFFECTS (HEGLEY ACOUSTIC CONSULTANTS 2013) 39

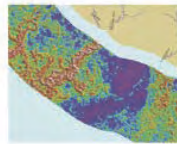
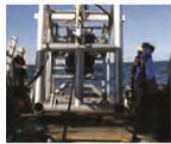

1.20.1	<i>EPA Review Findings</i>	39
1.20.2	<i>Joint Expert Conferencing Results</i>	40
OCEANOGRAPHIC INFORMATION		41
1.21	TTR REPORT: SOUTH TARANAKI BIGHT IRON SAND MINING: OCEANOGRAPHIC MEASUREMENTS DATA REPORT (MACDONALD ET AL. 2013A)	41
1.22	TTR REPORT: NEARSHORE OPTICAL WATER QUALITY IN THE SOUTH TARANAKI BIGHT (MACDONALD ET.AL 2013B).....	42
1.22.1	<i>EPA Review Findings</i>	43
1.22.2	<i>Joint Expert Conferencing Results</i>	43
OTHER MARINE MANAGEMENT REGIMES		44
1.23	TTR REPORT: OTHER MARINE MANAGEMENT REGIMES ASSESSMENT (BOFFA MISKEL 2013)	44
1.23.1	<i>EPA Review Findings</i>	44
1.23.2	<i>Joint Expert Conferencing Results</i>	45
RECREATION		45
1.24	TTR REPORT: RECREATION AND TOURISM ASSESSMENT OF EFFECTS (GREENAWAY AND ASSOCIATES 2013)	45
1.24.1	<i>EPA Review Findings</i>	47
1.24.2	<i>Joint Expert Conferencing Results</i>	47
SEDIMENT TOXICOLOGY		48
1.25	TTR REPORT: IRON SAND EXTRACTION IN SOUTH TARANAKI BIGHT: EFFECTS ON TRACE METAL CONTENTS OF SEDIMENT AND SEAWATER (VOPEL ET.AL 2013)	48
1.25.1	<i>EPA Review Findings</i>	50
1.25.2	<i>Joint Expert Conferencing Results</i>	50
SHORELINE PROFILE		50
1.26	TTR REPORT: SHORELINE MONITORING DATA REPORT (MACDONALD ET.AL 2012)	50
1.26.1	<i>EPA Review Findings</i>	51
1.26.2	<i>Joint Expert Conferencing Results</i>	51
SOCIAL EFFECTS		52
1.27	TTR REPORT: SOCIAL IMPACT ASSESSMENT OF TRANS-TASMAN RESOURCES LTD IRON SAND MINING PROJECT (CORYDON ASSOCIATES LTD. 2013).....	52
1.27.1	<i>EPA Review Findings</i>	53
1.27.2	<i>Joint Expert Conferencing Results</i>	53
VISUAL EFFECTS		53
1.28	TTR REPORT: SEASCAPE, NATURAL CHARACTER & VISUAL EFFECTS ASSESSMENT (BOFFA MISKELL LTD. 2013B).....	53
1.28.1	<i>EPA Review Findings</i>	55
1.28.2	<i>Joint Expert Conferencing Results</i>	55
WAVE AND SURF EFFECTS		56
1.29	TTR REPORT: NEARSHORE WAVE MODELLING PHASE 4 STUDIES (GORMAN 2013).....	56
1.29.1	<i>EPA Review Findings</i>	56

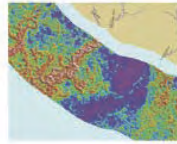
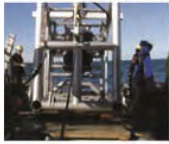

1.29.2	Joint Expert Conferencing Results.....	56
1.30	TTR REPORT: POTENTIAL EFFECTS OF TRANS-TASMAN RESOURCES MINING OPERATIONS ON SURFING BREAKS IN THE SOUTHERN TARANAKI BIGHT (eCOAST LTD. 2013)	57
1.30.1	EPA Review Findings.....	57
1.30.2	Joint Expert Conferencing Results.....	57

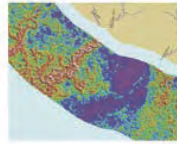
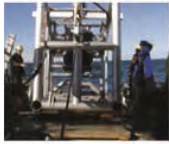

INTRODUCTION

This report provides a summary of the assessments commissioned by Trans-Tasman Resources Limited (TTR) to understand the actual and potential environmental effects of its proposed iron sand recovery operations in the South Taranaki Bight.

TTR is intending to utilise many of the environmental assessments it previously commissioned to support its earlier application for marine consent from the Environmental Protection Agency (EPA) in 2013 / 2014. In some circumstances these reports are being updated and revised to address matters raised by the Decision-Making Committee (DMC) in its decision on TTR's previous application, and to address revisions to the sediment plume and optics modelling. As such, it is considered appropriate in this report to also document the findings of the peer reviews undertaken by the EPA in 2013/2014 and the outcomes of any joint expert conferencing sessions at the time. This information provides context on the appropriateness of the environmental assessments commissioned by TTR.

The findings of each specialist report are presented, along with the findings of EPA reviews of those reports together with the outcome of 2014 conferencing sessions that involved experts from TTR and all other parties involved with the 2014 hearing of TTR's applications.

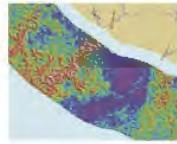

AIR DISCHARGES

1.1 TTR Reports: Air Dispersion Modelling Study (T&T Reference 29303)

TTR commissioned Tonkin and Taylor Ltd (T&T) to assess the dispersion and effects of emissions from the combustion of Heavy Fuel Oil (HFO) from its proposed gas turbine or reciprocating engine power generation systems. This assessment was initially undertaken in August 2013, and updated by T&T in September 2015.

Discharges to air from the HFO fired gas turbines or reciprocating engines comprise combustion products, including carbon monoxide, oxides of nitrogen, sulphur dioxide and fine particulate matter. The expected emissions to air were characterised based on information provided by TTR's proposed suppliers and published emission factors. The maximum ground level concentrations of contaminants on land were predicted using air dispersion modelling and the results of the modelling were compared to appropriate air quality assessment criteria, including the National Environmental Standards for Air Quality (NESAQ).

The modelling predicted maximum ground level offshore concentrations of NO^2 and SO^2 (1 hour (99.9%) and 24 hour averages) to exceed the relevant New Zealand air quality standards and guidelines. These maxima are predicted to occur close to the Integrated Mining Vessel and are located outside the 12 nautical mile limit, where people are most unlikely to become exposed to these contaminants.

Contaminant	Time average	Maximum Ground Level Concentration ($\mu\text{g}/\text{m}^3$)		Air assessment criterion ($\mu\text{g}/\text{m}^3$)
		Offshore	Onshore	
Particulate matter (PM_{10})	24 hour	4.4	0.6	50
	Annual	0.14	0.024	20
Nitrogen dioxide	1 hour (99.9%)	313	60	200 (9 exceedance allow per 12 months)
	24 hour	160	22	100
	Annual	5.3	0.9	40
Sulphur dioxide	1 hour (99.9%)	453	87	350 (9 exceedances allow per 12 months) 570 (not to exceed)
	24 hour	231	31	120 (20*)
Carbon monoxide	1 hour (99.9%)	75	14	30,000
	8 hour	67	12	10,000

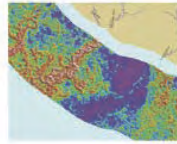
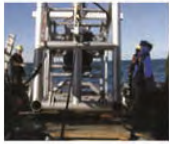

1.1.1 EPA Review Findings

The EPA engaged Sinclair Knight Merz (SKM) to carry out an independent technical review of the T&T assessment.

The SKM review found that the T&T assessment provided a concise and comprehensive assessment of the effects of the air discharges. The SKM review found that T&T has used conservative assumptions in some cases (assuming all NO_x as NO²), and used maximum expected conservative sulphur contents in fuel, as well as assuming maximum continuous emissions over the year which provided conservatism to the assessment, particularly for the longer term.

The SKM review further found that the predicted onshore emission concentrations were well below the assessment criteria, so any further refinement of emission rates would not be necessary.

1.1.2 Joint Expert Conferencing Results

A teleconference was held between experts on air quality and health effects on 19 March 2014.

The experts noted that the T&T modelling predicted that the air concentrations of sulphur dioxide exceeded the ambient air quality standards (AAQS) at the Kupe platform, but also noted that the air concentrations were within the NZ Workplace Exposure Standards. As such, the modelled concentrations were not significant with regards to air quality or health effects.

With respect to exposure of recreational users to generated emissions, the experts found that although the dispersion modelling showed that the AAQS for sulphur dioxide would be exceeded in certain areas the predicted concentrations were not at levels that would cause adverse health effects.

The experts considered it appropriate to include a requirement for a condition that would limit the sulphur content of the fuel. All air quality and health effects assessments were based on a sulphur content of 3.5 %w/w (by weight) and therefore this was considered an appropriate limit.

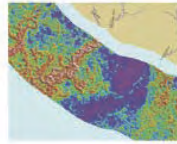
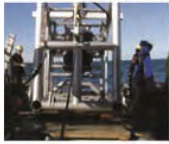

ARCHAEOLOGICAL

1.2 TTR Report: Archaeological Assessment (Clough & Associates Ltd)

TTR engaged Clough & Associates Ltd in August 2013 to assess the potential for the discovery of historic shipwreck sites within the proposed area of operations.

Clough & Associates (2013) review of NIWA's multi-beam sonar data found that there is no significant wreckage exposed above the seabed in the project area, although it is still possible that wreckage could be encountered buried beneath the seabed. They also concluded that additional archaeological monitoring of iron sand recovery operations in the project area would not be necessary.

Should a shipwreck be encountered during iron sand recovery operations, Clough & Associates (2013) recommended the following procedures be implemented:

- Should a number of finds be found in a discrete area, or substantially intact wreckage encountered, efforts would be made to identify what it is and its likely age. In the first instance photographs and a description of the find would be sent to a consultant archaeologist for identification;
- Work would cease in the immediate area while the find is identified. If the wreckage is not a legally protected archaeological site (post-dating 1900), a record should be made of the find and works can resume;
- If the finds are confirmed as being a legally protected archaeological site (pre-dating 1900), it will be necessary to contact the New Zealand Historic Places Trust Regional Archaeologist in the first instance and obtain an archaeological authority from the New Zealand Historic Places Trust before works affecting the site can proceed. This is a legal requirement under the Historic Places Act 1993.

1.2.1 EPA Review Findings

Clough & Associates (2013) was not peer reviewed by independent specialists on behalf of the EPA. The findings of the assessment were accepted by all parties at the 2014 hearing.

1.2.2 Joint Expert Conferencing Results

Clough & Associates (2013) was not subject to expert conferencing. The findings of the assessment were accepted by all parties at the 2014 hearing.

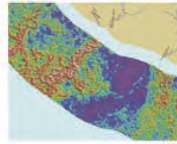
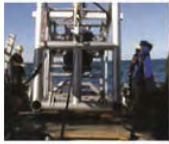

BASELINE ENVIRONMENTAL REPORT

1.3 TTR Report: South Taranaki Bight Factual Baseline Environment Report (MacDiarmid et al. 2011)

TTR commissioned NIWA in 2010 to undertake phased bio-geophysical research in the South Taranaki Bight, focused on collecting and presenting data from existing sources presenting the existing conditions of the following elements:

- Derivation of wave climate information and tidal patterns for the region from existing models and databases;
- Undertaking a geomorphologic analysis of stability and history of adjacent shore;
- Characterisation of the ecology of the region including a synthesis of information about rare and endangered species; and
- Characterisation of the fisheries of the region.

With regards to the wave climate and tidal patterns for the South Taranaki Bight, the data shows a seasonal variation in wave heights, with the highest waves on average occurring in August and September. In storm conditions, significant wave heights of order 8m can occur, particularly in the winter and early spring. Peak wave periods are most commonly in the range 10-14 seconds.

While not quite as strong as tidal flows through Cook Strait proper, tidal currents of up to 0.4m/s occur in the relatively shallow waters off Patea and smaller (with peak speeds less than 0.1m/s) in nearshore waters between Wanganui and Foxton.

It is likely that shoreline processes will continue to be driven by geology and climate cycles. The South Taranaki Bight is dominated by eroding volcanic and sedimentary cliffs and dynamic river mouths. South of Whangaehu River the shoreline is dominated by dunes, backed by sand country, which are likely extending due to windblown sand. Rivers and estuaries also feature in this area and cause the shoreline to move back and forth over long time periods.

The available information indicates that the South Taranaki Bight is biologically productive in terms of meso (midsized) zooplankton. Biomass estimates are among the highest recorded compared to other coastal regions around New Zealand. The mesozooplankton species composition is strongly influenced by the physical oceanography of the region, including both the upwelling events off Cape Farewell and the D'Urville current.

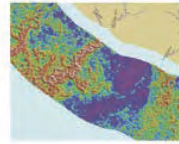

The data indicates that the benthic fauna in the South Taranaki Bight is generally species poor, with a low abundance of benthic organisms in both subtidal and intertidal zones when compared to other coastal areas of New Zealand. Benthic species richness and abundance are particularly low in sandy habitats which may be due to the high energy environment and frequent seabed resuspension resulting in very mobile sediments, sand inundation of reefs, sand scouring of reef habitats and sustained high water turbidity in nearshore areas. Species numbers and diversity tend to increase towards the shore, with the highest numbers in the nearshore area.

A productive zone for invertebrates in the southwest of the study area is evident where high wet weights of squid, octopus and decapods (crabs, shrimps etc.) have been recorded. This offshore productive zone is most likely due to the influence of the cold, nutrient-rich water that originates from the upwelling zone off Cape Farewell and the Kahurangi shoals.

No nationally endangered or at-risk benthic macrofaunal species were found to be present within the area. However, the Waitotara estuary, Waiinu reef, Waverley Beach, North and South Traps, Whenuakura estuary and Whanganui river estuary are all identified as being “outstanding natural areas” in the Taranaki Regional Coastal Plan 1997.

The South Taranaki Bight has a moderately diverse reef fish fauna with only 38 species predicted to occur on reefs within SCUBA diving depth range (30m). Two species, black angelfish and common roughly, are predicted to be rare in the region, occurring at low abundance at just a few coastal reefs.

Six other species have restricted distributions, predicted to occur at <50% of the reef sites in the region. All other 29 species are predicted to be much more widespread and either occur in low abundance throughout the region (14 species), are moderately common over the entire area (13 species), or are abundant widely-distributed species (2 species).

Fifty-one species of demersal fish occur in the South Taranaki Bight. The richness of this assemblage is moderate on a New Zealand wide scale, with on average 12-16 species likely to occur within a standard research tow.

Species with distributions along the South Taranaki coastline that coincide with areas of interest to TTR include anchovy, blue cod, eagle rays, red gurnard, golden mackerel, leather jacket, lemon sole, snapper, rig and trevally.

The South Taranaki Bight supports a relatively modest seabird assemblage. Many of the species occurring in the area are likely to be relatively coastal in their distributions. Such species include blue penguin, shags, gulls and terns, although these latter taxa can extend to more offshore areas.

The area does not support large breeding colonies for any species but a number of coastal estuarine sites are of significant value to coastal, shore, wading, and migratory bird species. These include the Waikirikiri Lagoon and the Whanganui, Whangaehu, Turakina, Manawatu and Rangitikei River estuaries.

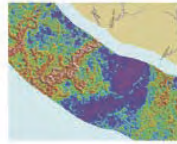
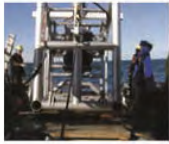

Commercial fishing operations within the South Taranaki Bight have been dominated in recent years by three main fishing methods, bottom trawling (for a variety of species), midwater trawling (mainly for jack mackerel), and set netting (mainly for rig, blue warehou and school shark). Together these methods have accounted for 95% of all fishing events recorded with position data, between 1 October 2004 and mid-July 2010. The highest levels of fishing effort (mainly bottom trawling and set netting) were just offshore between New Plymouth and Cape Egmont, and near the 50 m contour between Hawera and Whanganui. Fishing effort of all methods occurred throughout the year, but there was a concentration of midwater trawling effort in early summer.

1.3.1 EPA Review Findings

The EPA engaged SKM to carry out a number of independent technical reviews that included the review of the NIWA baseline environment report. The SKM reviews all found that the baseline environment report presented the best available information.

1.3.2 Joint Expert Conferencing Results

The NIWA 2011 Baseline Report was not subject to expert conferencing. The findings were accepted by all parties at the 2014 hearing.

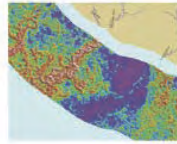
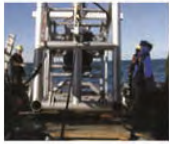

BATHYMETRY SIDE-SCAN & SEISMIC REPORTS

1.4 TTR Report: Multibeam Survey in Southern Taranaki Bight (Pallentin et al. 2013)

TTR contracted NIWA in 2012 to conduct a multi-beam bathymetry survey of the South Taranaki Bight.

The depth range and seafloor morphology of the area varied widely. The shallowest measured depth was just under 10m water depth at the end of the Wanganui outfall pipeline, the deepest in the planned IMV mooring site area with just under 80m water depth. The only notable feature, outside of the known nearshore rocky systems, was a field of what appeared to be outcrops, rising 1- 5m above the seafloor, west of the Traps.

1.4.1 EPA Review Findings

The EPA engaged SKM to undertake a review of the technical assessments relation to oceanographic processes and the physical environment, including Pallentin et al. 2013. SKM noted that the majority of the material provided about the physical environment by TTR is comprehensive and makes use of the best available information. With respect to Pallentin et al. 2013, SKM noted that it represented a routine technical data report and covered the entire proposed project area.

1.4.2 Joint Expert Conferencing Results

For the 2014 hearing, conferencing on bathymetry and oceanographic processes took place on 20 March 2014. The experts agreed that the oceanographic measurements by TTR are fit for purpose and to international standard. They also agreed there were no areas of uncertainty beyond the normal measurement error and natural variation implicit in any field measurements.

1.5 TTR Report: High-resolution Boomer Survey in South Taranaki Bight 2nd Survey (Woelz and Wilcox 2013)

TTR contracted NIWA in 2013 to run a set of 20 seismic lines using a Boomer system to help understand the geometry of the sedimentary wedge in the South Taranaki Bight within which iron sand-rich deposits occur. A short factual report was provided.

1.5.1 EPA Review Findings

The EPA engaged SKM to undertake a review of the technical assessments in relation to oceanographic processes and the physical environment, including Woelz and Wilcox (2013). SKM noted that Woelz and Wilcox (2013) was a routine technical data report, but that the survey did not cover the proposed project area (they stated that it refers to previous survey that does cover the project area).

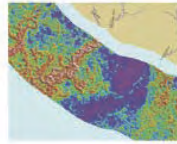
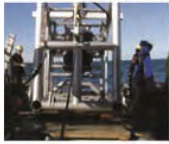

1.5.2 Joint Expert Conferencing Results

Woelz and Wilcox (2013) was not subject to expert conferencing. The factual findings of the survey were accepted by all parties at the 2014 hearing.

1.6 TTR Report: Sidescan Survey of South Taranaki Bight Sediments (Gerring et al. - 2012)

A sidescan survey was undertaken off the South Taranaki coast by NIWA in 2012 in order to attempt to identify the extent of bryozoans and sponges within an area being considered at the time for the disposal of dredge spoil from the iron sand recovery operations. The project no longer involves the use of a dump site as initially envisaged when the sidescan survey was commissioned. However, the data regarding the extent of bryozoans and sponges on the seabed remains valid.

The sidescan images were verified using underwater photographs and maps were generated showing the extent of the bryozoan - sponge habitat in relation to the proposed spoil disposal site.

The sidescan study indicated a large area of biogenic-dominated habitat predominately on the south-eastern part of the study area in water depths of 70–90m. Bryozoans and sponges form scattered clumps over the whole of this area, with clump height (estimated maximum height 250–300m) and occurrence decreasing gradually to the west until the sea-floor substrate can be reclassified as muddy sand with bryozoan and/or shell fragments. Further inshore, towards the outer iron sand recovery area, there are extensive areas of dark fine sand with shell fragments. Large sand waves seen in the more northern parts of the study area are possibly generated and maintained by currents that occur during westerly and south-westerly storms. However, it is also possible that these sand waves were formed during the last post-glacial sea-level rise. Almost all of the remainder of the area covered in the survey is described as being gravelly mud, up to 1–3m thick (from previous studies).

1.6.1 EPA Review Findings

The EPA engaged SKM to undertake a review of the technical assessments relation to oceanographic processes and the physical environment, including Gerring et al. (2013). SKM noted that Gerring et al. (2013) was a routine technical data report, although the coverage of the project area was not comprehensive.

1.6.2 Joint Expert Conferencing Results

Gerring et al. (2012) was not subject to expert conferencing. The findings of the survey were accepted by all parties at the 2014 hearing.

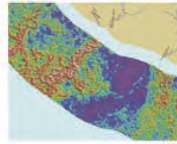
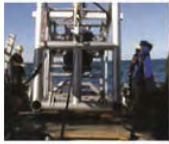

BENTHIC STUDIES

TTR engaged NIWA in 2013 to survey and describe the benthic flora and fauna within the South Taranaki Bight.

1.7 TTR Report: Benthic Habitats, Macrobenthos and Surficial Sediments of the Nearshore South Taranaki Bight (Anderson et al. 2013)

Seabed sampling of the nearshore region of the South Taranaki Bight was conducted during February and March 2013. Seabed habitats were characterised using underwater video footage and still images. Representative habitats were then sampled using a benthic grab for surficial sediments (surface sediments) and a benthic dredge to collect surficial macrobenthic specimens.

Both soft-sediment and rocky outcrop habitats were recorded within the nearshore region of the South Taranaki Bight. The exposed areas in the north and central regions of the South Taranaki Bight were characterised by well-sorted fine sands in dynamic rippled bedforms, while the more protected southern sites were characterised by flat or subtly rippled bedforms with higher proportions of mud. The amount of shell debris associated with soft-sediment habitats also increased offshore, with coarse-shell debris habitats recorded in water depths greater than 20m.

Two types of rocky outcrops were recorded. Hard rock outcrops of low to moderate relief were recorded at three sites in the northern sections of the South Taranaki Bight in water depths of 12-22m, while two mudstone outcrops were recorded: one south of Hawera as a low-lying outcrop at 14 m and another offshore of Whanganui as a moderate relief outcrop at 13.5m.

Video observations of the seabed along with dredge collections at representative sites found that most soft-sediment sites supported very low numbers of surficial macrobenthos. These assemblages were characterised by deposit feeders, predators/scavengers and suspension feeders.

Rocky outcrops, which represent 8% of available habitats, supported much more abundant and diverse macrobenthic assemblages. These assemblages were characterised by bryozoans, macroalgae and sponges, as well as more motile species, such as crabs, amphipods, starfish, brittle stars, gastropods and polychaetes worms. In contrast to mudstone outcrops, which supported low or negligible amounts of macrobenthos, hard rock outcrops accounted for more than 25% of all specimens and 61% of all species collected during the survey.

No records of new species were found.

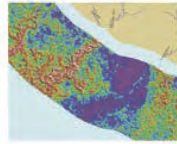

1.8 TTR Report: Benthic Flora and Fauna of the Patea Shoals Region, South Taranaki Bight (Beaumont et al. 2013)

This survey concentrated on an area of seabed known as Patea Shoals, approximately 25-40km offshore in water depths of 25-45m. As part of this study, NIWA was also contracted by TTR to experimentally compare the recolonisation of iron rich and de-ored sediments by benthic organisms.

The most common habitat observed was rippled sands, which occurred across most of the area in depths of 15-50m. Areas of the seabed were characterised by worm communities, termed 'wormfield' habitats. These habitats were dominated by the infaunal tubeworm, *Euchone* sp A, which live in the upper sediments where they bind sediments together to form their tubes, and can occur in high but patchy densities. Overall, inner and mid-shelf habitats supported very few visible epifauna.

In deeper areas offshore, the seabed was characterised by two types of low-relief biogenic habitat: bivalve rubble and bryozoan rubble. Bivalve rubble were characterised by the large robust dog cockle *Tucetona laticostata*, both living buried in the sediments and with relict shells that have accumulated on the surface of the seabed. Live *T. laticostata* were recorded in water depths of 26-83.5m, while the shell debris of this species – that formed the dominant biogenic structure in deeper offshore areas - occurred within a much narrow depth contour (44-69m depths). In deeper zones (>60m), bryozoan rubble combined with more generic shell debris became the dominant habitat type. These biogenic habitats both supported diverse benthic assemblages dominated by sessile suspension-feeding taxa (e.g. bryozoa, sponges, colonial ascidians, brachiopods and epiphytic bivalves), and in turn provide structure to a plethora of motile species (e.g. crabs, ophiuroids, holothurians, gastropods, and nudibranchs).

The re-colonisation experiment was carried out at two sites (Mahanga Bay and Evans Bay) within Wellington Harbour. At each site, three replicates of each of three experimental treatments were deployed, using treatments of high-iron, medium-iron and low-iron (de-ored sand) concentrations. The sand used in the experiment was collected from within the proposed project area. The concentration of Vanadium Titano-Magnetite in the surface sediments appears to play an insignificant role in structuring marine benthic communities in the study area. This is further supported by results of the recolonisation experiment which showed that the concentration of iron in sediments was not a key driving factor in the re-colonisation of soft-sediment (sandy) communities at either of the Wellington Harbour study sites.

Overall, there was no evidence within the data to suggest that the proposed extraction of de-ored sand deposit areas are "unique" with respect to macrofauna collected/observed during the survey. Importantly, neither the video observations, dredges, sediment cores nor the recolonisation experiment showed a significant relationship between iron concentration and community structure.

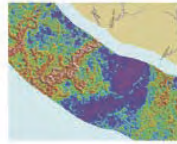
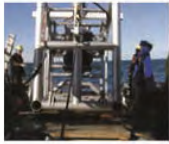

1.8.1 EPA Review Findings

The EPA engaged SKM to undertake an independent review of the benthic studies.

The findings of the SKM benthic review were:

- That the benthic studies were significant additions to the current knowledge of benthic communities in the South Taranaki Bight and, as such represented the best available information; and
- That the results of Beaumont et al. (2013) demonstrated that there were no differences between benthic communities in the proposed iron sand recovery area and adjacent communities in similar habitats.

The main criticisms of the benthic studies focussed on the lack of information regarding the North and South Traps, two high-relief rocky reef systems located six kilometres off Patea, and the failure of the studies to relate predicted changes in suspended sediment concentration and sediment deposition to consequent changes in the availability of light to light-dependent benthos, and potential impacts.

1.8.2 Joint Expert Conferencing Results

As part of the first hearing, conferencing of experts on the effects on benthic ecology took place over two days in March 2014.

The experts considered the following aspects concerning the effects on benthic ecology:

- Methodological adequacy to support evidence-based decision making;
- Levels of uncertainty around predicted effects;
- Acute and chronic effects of the sediment plume and sedimentation on benthic ecology;
- Effects of shading on primary productivity;
- Effects of the sediment plume and sedimentation on offshore biogenic habitats and other potentially sensitive receptors;
- Factors affecting recovery of infauna and epifauna assemblages post iron sand recovery activities;
- Benthic habitats and significance of inshore reef areas located down current from mining site (e.g., the North and South Traps and Graham Bank);
- Sensitivity of *Ecklonia* and other reef assemblages to the predicted reductions in incident light (and relevance of thresholds);
- Concentration of metals and hypersaline brine in water discharges from the plant and dilution required to meet ANZECC/ARMCANZ guidelines;
- Is there any knowledge of freshwater springs in the application area? If so, what is the likely effect on them?; and
- Environmental monitoring;

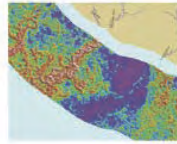

- Objectives;
- Baseline monitoring—duration pre-activities;
- Relative utility and applicability of trigger level/thresholds-based or other environmental monitoring approaches; and
- Parameters, frequency, locations to monitor.

With regards to the methodological adequacy to support evidence-based decision making the experts agreed that:

- The benthic ecology surveys undertaken were spatially intensive and provided large amounts of information on the types of habitats, as well as the epifaunal and infaunal animals and plants present. However they do not provide any information on the temporal variability in this system;
- That temporal sampling was required to determine seasonal variability as part of a baseline monitoring survey;
- That 1-2 years of temporal monitoring was required as part of a baseline monitoring survey; and
- That a baseline monitoring program should be part of consent conditions.

Regarding levels of uncertainty around predicted effects, the experts found that:

- With the removal of the magnetite the chemical and physical structure of the depositional sediments will be altered within the iron sand recovery area;
- Mining activities will result in near total mortality of benthic fauna within the iron sand recovery area;
- Re-deposited sediment would be similar in sediment grain size to pre-mined sediments. The experts agreed that this would need to be measured at periods following iron sand recovery, with the frequency of monitoring of sediment grain size, especially of surficial sediments, being agreed prior to any operations occurring;
- Redox (reduction-oxidation potential, a measure of oxygen availability) measurements are likely to be important to recolonising organisms and that redox levels should be measured as part of ongoing monitoring surveys; and
- There is uncertainty in the rate of recovery of mined areas.

With regards to the effects of shading on primary productivity, the experts concluded that light modelling should not be taken as a reliable indicator of benthic primary production. Pelagic primary production is likely more important within the area than benthic primary production.

With regards to the effects of the sediment plume and sedimentation on offshore biogenic habitats and other potentially sensitive receptors the experts agreed that:

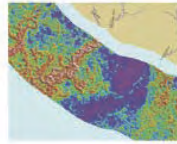
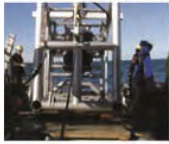

- Deposition of extraction derived sediments are unlikely to have an impact on the offshore communities in biogenic habitats; and
- There will be little effect on species (relating to choking) and the area is unlikely to be affected.

With regards to the recovery of infauna and epifauna assemblages post the iron sand recovery activities, the experts came to the conclusion that:

- The recovery of benthic ecosystems within the directly impacted mining area is in the order of a decade where mining has moved on from an area; and
- Recovery refers to the restoration of the ecological functional roles of the area. Dr Huber and Dr McClary agreed that some recovery will occur on shorter time scales.

With regards to the benthic habitats and significance of inshore reef areas located down current from the proposed iron sand recovery area (e.g., the North and South Traps and Graham Bank), the experts agreed that:

- The North and South Traps are beyond the primary area regularly exposed to elevated concentrations of mining-derived suspended sediments, so are unlikely to be affected by the activities; and
- Due to their regional significance as having outstanding coastal value, these areas (the North and South Traps and Graham Bank) should be monitored to detect potential effects of the activities.

With regards to the sensitivity of ecklonia and other reef assemblages to the predicted reductions in incident light (and relevance of thresholds) the experts agreed that:

- Mining derived sediment is not expected to have an additional effect on these rocky reef communities; and
- The North and South Traps should be monitored.

With regards to the concentration of metals and hypersaline brine in water discharges from the mining plant and dilution required to meet ANZECC/ARMCANZ guidelines, the experts agreed that:

- Concentrations of nickel and copper in the discharged seawater were unlikely to negatively affect any re-colonisation of the seafloor; and
- On a recommendation to include analyses of mercury in TTR's water quality monitoring program until the expectation that the extracted sediment will not release mercury is confirmed.

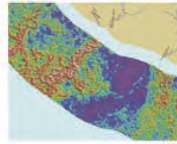
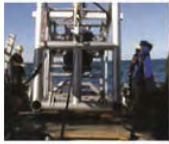

CETACEAN SURVEY AND HABITAT MODELLING

1.9 TTR Report: Habitat Models of Southern Right Whales, Hector's Dolphin, and Killer Whales in New Zealand (Torres et al. 2013)

The proposed iron sand recovery activities will affect the seafloor community at the extraction sites, while the sediment plume associated with the discharge of sediment back to the seabed has the potential to affect pelagic and benthic ecosystems downstream. Cetaceans (whales and dolphins), as important high level predators in marine systems, may be impacted by these activities.

A preliminary assessment of cetacean distribution in the South Taranaki Bight identified the presence of three endangered species: southern right whales, Hector's dolphins (*Cephalorhynchus hectori* and the sub-species Maui's dolphin *C.H. Maui*), and killer whales.

The study found that the proposed project area in the South Taranaki Bight appears to be of low suitability for all three species of cetaceans. Areas of increased habitat suitability for Hector's dolphins and southern right whales lie close inshore and may be increasingly used as the New Zealand populations of these species recover. An area of average to above average habitat suitability for killer whales begins approximately 8km seaward of the proposed project area.

1.10 TTR Report: Cetacean Monitoring Report (Martin Crawthorn Associates 2013)

TTR engaged Martin Crawthorn Associates Ltd in 2013 to conduct a cetacean survey of the distribution of cetacean across a large proportion of the South Taranaki Bight, including the proposed iron sand recovery area. The survey area was designed to cover TTR's "initial" area for iron sand recovery areas - which extended offshore from approximately Manaia in the north-west to between Patea and Waverley in the south-east.

The key results of the survey were as follows:

- A pod of common dolphin (6-8) was observed in the October 2012 survey within the project area;
- Very low densities of fur seals were observed between July 2011 and June 2013 on transects all outside of the project area, closer to shore;
- A variety of other fauna were also observed including seabirds, fish (usually mullet or kahawai) and sharks; and
- A total of approximately 4,550nm (or 8,426 km) of transect was flown to date which equates to approximately 7,300nm² (or 25,040km²).

Overall, the assessment concluded that the abundance of marine cetaceans within the project area is very low.

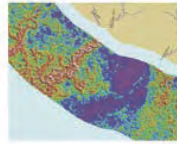
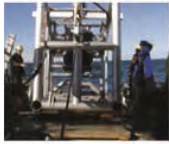

1.10.1 EPA Review Findings

The EPA engaged SKM to carry out an independent review of the technical reports related to marine mammals and fish.

The SKM review found that the approach employed within the habitat model was reasonable in order to identify some key species for consideration, although the potential for other cetacean species to be present in the area should be acknowledged.

Despite some gaps within the report (i.e. humpback whale seasonal migration routes and the possibility of beaked whale presence), the SKM review concluded that considering data from sightings, modelling and field surveys there is a very low abundance of cetaceans in the project area.

1.10.2 Joint Expert Conferencing Results

As part of the first hearing, conferencing of experts on the field of effects on marine mammals including noise took place in March 2014. As part of this joint expert conference the following issues regarding the conducted surveys and habitat modelling were discussed:

- Presence of marine mammals in the proposed project area and broader area; and
- Status/significance of the project area for marine mammals (e.g. feeding, migrating).

The experts agreed a species by species approach was appropriate when considering the presence of marine mammals in the project area and broader area.

The experts agreed that all species reported in the South Taranaki Bight Factual Baseline Environmental Report (MacDiarmid et al. 2011) (i.e. Hector's dolphin, southern right whale, killer whale, Maui's dolphin, blue whales, bottlenose dolphins, common dolphins, dusky dolphins, false killer whales, fin whales, humpback whales, minke whales, pilot whales, sei whales, sperm whales and NZ fur seals) could occur within the proposed iron sand recovery area.

The experts concluded that the south Taranaki coast is considered to be part of the historic natural range for Maui's dolphins, and is on the margins of their current range. While most records and sightings of Maui's dolphins are between the Kaipara Harbour and Raglan, Maui's dolphins have been recorded as far south as Whanganui with their relative density decreasing southward of Cape Egmont. Hector's dolphins have also been recorded in the South Taranaki Bight area but very rarely.

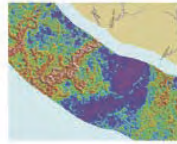
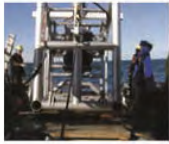

With regards to whales the experts agreed that:

- Killer whale groups are likely to be transitory through the South Taranaki Bight;
- Blue whale sightings mainly occurred in the general vicinity of the 100m depth contour with very few sightings inshore;
- The proposed iron sand recovery area may represent the edge of the blue whale feeding area, but feeding may still extend into the project area on occasion;
- The experts agreed that beaked whales are generally found in deep water with feeding typically occurring below 200m. Therefore, beaked whales are unlikely to be found in the project area or in waters less than 200m deep;
- Sperm whales are generally found in deep water like beaked whales;
- Humpback whales are likely to be seasonally present in the South Taranaki Bight ;
- Southern right whales are likely to be present in the South Taranaki Bight area seasonally and travel through in low numbers;
- Pilot and false killer whales may use the South Taranaki Bight, particularly over the summer months;
- Common dolphins are widespread around the South Taranaki Bight; and
- New Zealand fur seals are found in the South Taranaki Bight year round.

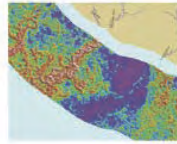
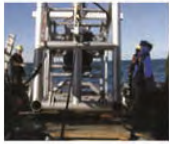

COASTAL STABILITY

1.11 TTR Report: Coastal stability in the South Taranaki Bight - Phase 2 Potential Effects of Offshore Sand Extraction on Physical Drivers and Coastal Stability (Hume et al. 2013)

TTR engaged NIWA in 2013 to assess the potential effects of the proposed iron sand recovery activities on physical drivers and coastal stability. The report made an assessment of the effects of sand extraction on the landforms and geomorphic character of the shore, physical drivers (waves and currents) of coastal processes, sediment processes and coastal stability, and was based on studies made of the natural landforms and geomorphic character along the 140km long stretch of coast between Opunake and Whanganui.

The key findings were summarised as follows:

- The natural landforms and geomorphic character of the beaches is unlikely to change due to the recovery of iron sand. Geomorphic character of the beaches is determined by environmental setting, tide range, grain size and wave climate;
- Public access to the marine environment will not be adversely affected;
- There will be no adverse effects from the deposition of substances to the seabed;
- The recovery of iron sand will not adversely affect physical drivers and processes that cause coastal change; and
- Effects on the risk of accelerated coastal erosion and accretion along the region's coastline and modification to natural hazard processes will not be significant.

1.11.1 EPA Review Findings

The EPA commissioned SKM to undertake a review of Hume et al. (2013). SKM agreed with the factual description contained in Hume et al. (2013) and agreed with the assessment that the impacts of iron sand recovery activities on the physical environment (including oceanographic and coastal processes) are likely to be minor. The SKM review noted that the significant distance of the project area offshore from the coast, and the depth of water, act to separate the influence of iron sand recovery from physical processes affecting the coastal zone, with only minor changes predicted to occur.

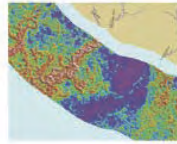

1.11.2 Joint Expert Conferencing Results

As part of the 2014 hearing, conferencing of coastal stability experts took place on 18 March 2014. This joint expert conference endorsed the methodology adopted for, and factual information in, Hume et al. (2013). It also agreed that NIWA's hydrodynamic and wave modelling used to generate inputs to the assessment of potential physical and coastal effects were consistent with international practice and appropriate.

The experts identified some uncertainty, albeit small, in relation to the pathways and magnitude of cross-shore sediment transport on the inner shelf, and agreed that it would be prudent to undertake further modelling/analysis to quantify the magnitude and patterns of cross-shore sediment transport on the inner shelf.

Overall, the experts agreed that sediment supply from the project area to beaches to the southeast is likely to be small, that changes to nearshore wave characteristics due to operations would be much smaller than natural variability in wave conditions, and that changes in wave energy incident on the coastline are unlikely to induce measurable changes in erosion and accretion patterns on the beaches.

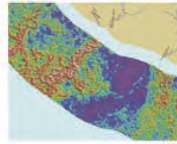
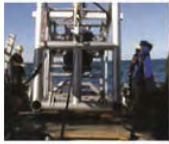

EFFECT OF SHIPS LIGHTS

1.12 TTR Report: Effects of Ships Lights on Fish, Squid and Seabirds (Thompson 2013)

TTR engaged NIWA in 2013 to assess the potential effects of ships lights on fish, squid and seabirds. The report drew upon the published literature to consider the effects of nocturnal artificial light on fish, squid and seabirds, taking into account the likely light regime on the Integrated Mining Vessel.

Overall, artificial nocturnal light generally attracts all three groups of marine animals to a certain extent. The attractiveness of light is not universal across these marine species. For example, the majority of diurnally-active seabirds appear not to exhibit marked attraction to artificial light, whereas light can potentially be a problem for nocturnal species.

For fish and squid, any effects of the vessel as a source of artificial nocturnal light are likely to be very localised and centred on the vessel itself. Some species of both groups could potentially aggregate in the water column close to the vessel, but these effects are highly unlikely to have any measurable population level impact on the attracted species.

Similarly for seabirds it is possible that the vessel's lights may attract nocturnal species, particularly in poor weather, but the remoteness of the area of operation from major seabird breeding colonies and relatively standard mitigation protocols would also suggest that any effect would be highly unlikely to have any measurable population level impact on the attracted seabird species.

1.12.1 EPA Review Findings

The EPA commissioned a review by Mitchell Partnerships Limited, which found that the anticipated effects on seabirds using the area described in Thompson (2013) had not considered any impacts due to reductions in food supply or the potential for reduced foraging success in turbid waters. The review concluded that Thompson (2013) did not contain sufficient detail to enable the EPA to understand the effects of the activity on the environment. The review also noted that no monitoring of seabirds was proposed, and therefore an adaptive management approach was precluded, unless a suitable monitoring regime can be devised. Mitchell Partnerships Limited concluded that additional information was required to allow a full and thorough understanding of the existing environment and the effects of the proposal in respect of seabirds.

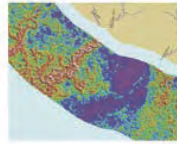
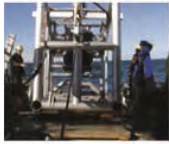

1.12.2 Joint Expert Conferencing Results

As part of the 2014 hearing, conferencing of seabird experts took place on 20 March 2014. The experts agreed that lighting was potentially the biggest issue with respect to effects on birds. They agreed that a detailed lighting risk mitigation plan should be developed and imposed as a condition of consent, along with monitoring and review conditions.

ZOOPLANKTON

1.13 TTR Report: Zooplankton and the Processes Supporting them in Greater Western Cook Strait (Bradford-Grieve and Stevens 2013)

Bradford-Grieve and Stevens (2013) reviewed available information about the zooplankton, and the processes supporting it, in the Greater Western Cook Strait (including the South Taranaki Bight, Tasman and Golden Bays, and bounded by Cook Strait Narrows), as this larger area influences zooplankton populations in the South Taranaki Bight. In summary, the review indicated the following in relation to the project:

- Zooplankton species composition in the South Taranaki Bight is typical of coastal waters found around North Island;
- Little is known of the seasonal cycle or inter-annual variability of plankton. The existing data has been mainly collected in summer. In addition, there is little knowledge of nearshore zooplankton assemblages;
- The Greater Western Cook Strait region is impacted by several large-scale, highly variable, physical phenomena that structure the distribution and biomass of zooplankton. These large scale physical processes include the Kahurangi/Cape Farewell upwelling plume, tidal mixing, river plumes and surf beach processes. Of these, the Kahurangi/Cape Farewell upwelling plume is the best understood in terms of plant nutrient renewal which impacts primary production and dynamics and its downstream impact on the zooplankton;
- Upstream in the plume, near Cape Farewell, although nutrients were high there is evidence of low breeding activity among copepods and zooplankton food requirements were not being met. But the reverse applied downstream, extending towards the South Taranaki Bight. There, concentrations of copepod nauplii, herbivorous copepods, and developmental stages of krill *Nyctiphanes australis* were much higher than at the plume origin;
- As this assemblage was transported north-eastwards, further oceanic copepod species were entrained which produced high species richness. Further east the proportion of herbivorous copepods, species diversity and zooplankton biomass increased; and
- The Manawatu River appears to impact phytoplankton biomass and production near shore. Nutrient recycling on Waitarere Beach, south of the Manawatu River, is probably related to the measured high productivity of surf diatoms.

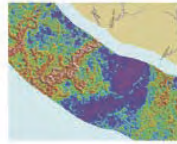
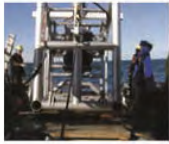

In her evidence which, was reviewed by the Joint Expert Conference on Zooplankton, Dr Janet Grieve the lead author of Bradford-Grieve and Stevens (2013), concluded that near-surface living zooplankton by their very nature are adapted to an environment that is disturbed. That is, in general, zooplankton must be able to function in surface waters that seasonally mix deeply in winter and be able to survive over winter in a low food environment. In addition, at some locations, environmental disturbance occurs naturally through processes such as upwelling of deep water, strong vertical mixing caused by tidal currents in shallow water, or strong mixing caused by the grounding of surface waves close to shore. Therefore, it is considered that zooplankton populations are able to recover from strong, naturally occurring disturbance.

Dr Grieve concluded that it would be highly unlikely that one could distinguish between the impact of additional disturbance from any recovery of iron sands and the already existing, multiple sources of natural disturbance occurring in the greater South Taranaki Bight.

1.13.1 EPA Review Findings

EPA commissioned SKM to undertake a review of Bradford-Grieve and Stevens (2013), along with assessments on marine mammals, fish and squid. The SKM review agreed that zooplankton communities of the South Taranaki Bight are typical of those in coastal waters across the North Island, and that factors influencing zooplankton in the region are highly variable.

The SKM review concluded that proposed iron sand recovery activities will result in increased suspended sediment concentrations within the water column, which is unlikely to cause impacts on zooplankton other than at a localised scale of hundreds of metres from the iron sand recovery activities. The ecological significance of such effects was considered by SKM to be minor, given the vast area of habitats in the coastal regions to the north, which will not be affected by the mining activity.

1.13.2 Joint Expert Conferencing Results

For the 2014 hearing, conferencing of fish and zooplankton experts took place on 20 March 2014. All experts agreed with the outcomes and facts on zooplankton provided in the Statement of Evidence in Chief of Janet Grieve as set out above.

The experts also agreed that conditions that require the monitoring of zooplankton were not necessary.

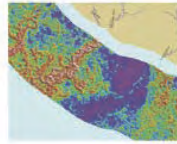
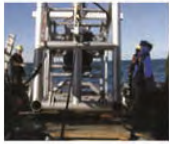

SEABIRDS

1.14 TTR Report Seabirds of the South Taranaki Bight (Thompson 2013)

TTR engaged NIWA in 2013 to assess the potential effects of the proposed iron sand recovery activities on seabirds in the South Taranaki Bight.

The South Taranaki Bight supports a relatively modest seabird assemblage, but detailed, systematic and quantitative information on the at-sea distribution of virtually all species is currently lacking. Many of the species occurring in the area are likely to be relatively coastal in their distributions. Such species include blue penguin, shags, gulls and terns, although these latter two taxa can extend to more offshore areas.

By contrast, and although some species have been observed from and relatively close to the coast, albatross and petrel species tend to be more pelagic and wide-ranging in their distributions and will likely occur anywhere throughout the area. The area does not support large breeding colonies for any species but a number of coastal estuarine sites are of significant value to coastal, shore, wading, and migratory bird species. These include the Waikirikiri Lagoon and the Whanganui, Whangaehu, Turakina, Manawatu and Rangitikei River estuaries.

1.14.1 EPA Review Findings

Mitchell Partnerships Limited was commissioned by the EPA to undertake a review of Thompson (2013). The review found that Thompson (2013) could have made better use of the available information to inform their assessment, and that Thompson (2013) did not adequately describe the current state of the affected area in sufficient detail to enable the EPA to understand the relative importance (or otherwise) of the existing environment and the nature of the effects of the activity.

Mitchell Partnerships Limited concluded that additional information was required to allow a full and thorough understanding of the existing environment and the effects of the proposal in respect of birds.

1.14.2 Joint Expert Conferencing Results

As part of the 2014 hearing, conferencing of seabird experts took place on 20 March 2014. This joint expert conference reviewed both of NIWA's bird reports, and agreed that reports and information provided to the EPA for the hearing were an adequate summary of what is known to date on the South Taranaki Bight area for seabirds. However, the experts agreed that there was not enough evidence to conclude that the area was of importance or was not of importance to seabirds.

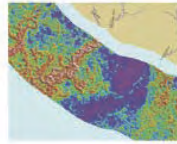
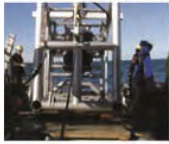

The experts agreed that the South Taranaki Bight could be on the migratory route of several New Zealand seabird species (e.g. the Sooty Shearwater and Hutton's Shearwater). However, the amount of time that these species spend in the area was unknown. The ability of these species to move their migration route was also unknown. The experts accepted that the South Taranaki Bight is of lesser importance than the Chatham Rise and the Snares/Solander Rise with respect to seabirds, due to those other places being recognised as areas of extremely high phytoplankton productivity, and being in close proximity to major seabird breeding colonies.

The experts agreed that the level of uncertainty was high and that some of the knowledge gaps needed to be addressed in order to fully assess the level of effects on birds. They agreed that if an adaptive management regime was to be implemented, it would need to respond to knowledge that could be gained from a targeted monitoring regime.

FISH IN THE SOUTH TARANAKI BIGHT

1.15 TTR Report: South Taranaki Bight Fish and Fisheries (MacDiarmid et al. 2013)

TTR commissioned NIWA to investigate the fish and fisheries of the South Taranaki Bight that may be impacted by the proposed iron sand recovery activities (MacDiarmid et al. 2013). The distribution and abundance of reef fish, pelagic fish, and demersal or seabed associated fish species were described using predictive models based on survey information conducted around New Zealand - along with an assessment of the distribution, abundance and ecology of rock lobsters on the basis of extensive studies conducted elsewhere in New Zealand.

Commercial fisheries for fin fish and rock lobsters in the South Taranaki Bight were described based on catch and effort information held by the Ministry for Primary Industries.

MacDiarmid et al. (2013) found the following:

- A range of marine habitats occur in the South Taranaki Bight that support a variety of organisms including reef fish and invertebrates, crayfish, demersal fish and pelagic fish species. The species richness of the reef fish, demersal fish and pelagic fish assemblages is moderate on a national scale. None of the strictly marine species reviewed in this report are nationally rare or threatened, although several diadromous species (species with a phase in both marine and fresh waters) occurring in the region are listed as 'at risk – declining';
- Some of the identified fish and invertebrate species support locally important commercial and customary fisheries. MacDiarmid et al. (2013) did not investigate the extent or location of recreational fisheries;
- The distribution of the marine life stages of diadromous fish in the South Taranaki Bight is unknown;

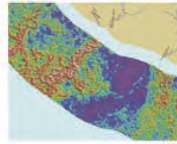
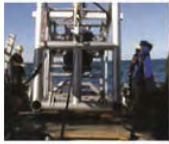

- There is some evidence for spawning activity by 13 demersal or pelagic fish species in the South Taranaki Bight, while larger juveniles of 24 species also occur in the region. However, the distribution of spawning adults and juveniles is poorly defined;
- Demersal and pelagic fish species with predicted distributions in the South Taranaki Bight that coincide with areas potentially affected by iron sand recovery operations include barracouta, blue cod, carpet shark, eagle rays, John Dory, golden mackerel, kahawai, leather jacket, lemon sole, red cod, red gurnard, rig, school shark, snapper, spiny dogfish, tarakihi, trevally, common warehou, and witch. Species that are predicted to be particularly abundant (> 50 kg per hour standard trawling) in the project area include barracouta, red gurnard, leather jacket, school shark, snapper, spiny dogfish, rig, tarakihi, and trevally.
- The demersal and pelagic fisheries likely to be most affected by iron sand recovery operations are the commercial set-net fisheries for rig, warehou, and school shark, and customary fisheries for rig and leather jacket. The greatest effort and catch in these commercial fisheries in the South Taranaki Bight is located to the south and east of the banks where the iron sand recovery operations are proposed to take place, while the greatest abundance of rig and leather jacket also occurs in this area; and
- At least 40 species of invertebrates and fish are customarily gathered or fished from the South Taranaki Bight. Harvesting sites vary from intertidal reefs to deep offshore areas and methods of collection vary from hand picking or gathering to specialised hook and line and potting techniques. Customary species occurring on inshore reefs most vulnerable to the effects of offshore sand extraction are sedentary species that cannot move sufficiently far or fast to avoid impacts. The customary fisheries offshore most vulnerable to the effects of iron sand recovery activities are those species which are abundant directly over the project area (such as rig and leatherjacket).

1.15.1 EPA Review Findings

The EPA commissioned SKM to undertake a peer review of MacDiarmid et al. (2013). The review by SKM concluded that predicted impacts of the proposed iron sand recovery activities on fish are low, and are primarily associated with direct impacts of fish being sucked into the pumping system during the iron sand recovery process. Additionally, fish are likely to be attracted to food entrained in the water column during operations and to the structure of the facilities for shelter. Lighting on the mining facility at night is also likely to attract some species of fish, squid and zooplankton. Fish appear to have a low abundance in the project area currently and SKM anticipated that changes in the community structure associated with establishing the iron sand recovery facility will be relatively localised (confined to an area of a few square kilometres).

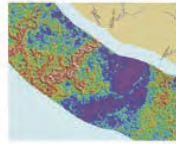
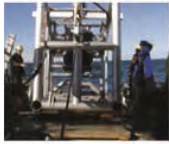

1.15.2 Joint Expert Conferencing Results

As part of the 2014 hearing, conferencing of fish experts took place on 20 March 2014. This joint expert conference agreed that:

- The assumptions of the fish distribution modelling and the implications for the impact assessment are appropriate;
- Given that adult fish have lower sensitivities to noise than marine mammals, the measures to mitigate the potential noise effects on mammals will also reduce the effects of noise on fish;
- The cumulative effects of increase of suspended solids is unlikely to cause sub-lethal effects or growth effects except at the immediate source of the plume;
- The application of the ANZECC/ARMCANZ 2000 Guidelines for Water Quality Protection is the appropriate standard for protection of zooplankton and fish populations;
- Detectable direct effects of decreases in water clarity on zooplankton and fish populations are highly unlikely;
- Given the proposed suction methodology and devices proposed, there will be no great opportunity for fish to gain entry into the iron sand recovery apparatus;
- The likely effects of light spill from the activities will be minor given the appropriate applications of industry guidelines that should be imposed by way of a condition; and
- Testing should be undertaken to ensure that the ANZECC/ARMCANZ 2000 Guidelines for Water Quality Protection are met.

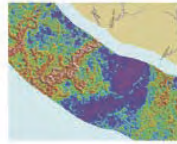
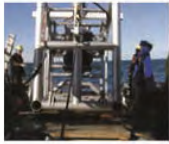

COMMERCIAL FISHING

1.16 TTR Report: Assessment of Potential Impacts on Commercial Fishing (Fathom Consulting Ltd. 2013)

TTR commissioned Fathom Consulting Ltd. to assess the potential impact of the proposed iron sand recovery operations on commercial fishing interests in the South Taranaki Bight.

The main commercial fisheries in the immediate project area are a mix of bottom trawl fishery for trevally, leatherjacket, gurnard and snapper, and a set net fishery targeting school shark, rig and blue warehou. Nearby fisheries include a coastal rock lobster fishery and, on the seaward side of the project area, a mid-water trawl fishery for jack mackerel and a small bottom longline fishery.

The bottom trawl fishery occurs over a particularly productive area known as “the rolling grounds.” The area is fished by one trawler based in New Plymouth and around a dozen from the top of the South Island, which visit on an occasional basis as part of their annual fishing plans. Although trawling effort occurs year round, the species taken show a distinct seasonality, with catches of many species peaking during the summer months.

The set net fishery has three main components. Rig is targeted in shallow waters within 4nm of the coast, school shark is targeted further out in waters around 50m deep, and blue warehou is targeted in shallow waters around Cape Egmont. Four set net vessels fish out of New Plymouth, often operating in all three target fisheries at different times of year, and several other vessels travel up from the South Island.

Quota ownership in both the trawl and set net fisheries is dominated by the large seafood companies Talleys and Sanford. Te Ohu Kaimoana Trustee is also a major quota owner on behalf of Maori, and several other iwi-owned companies feature in the top 10 quota owners for stocks in this area.

The assessment found that as the amount of displaced catch in both the trawl and set net fisheries would be small, it was unlikely that there would be any wider negative impacts on the commercial fishing industry – in particular, no negative impacts on quota value, downstream businesses, or fish stock sustainability are anticipated as a consequence of spatial displacement.

In the adjacent waters, the dispersal of the sediment plume is a key consideration. Further out in the EEZ the iron sand recovery operations are unlikely to have any negative effects on the mid-water trawl and bottom longline fisheries as the target fish species can migrate out of any areas affected by sediment dispersal.

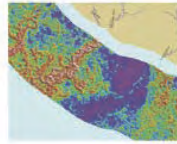

Fathom Consulting Ltd (2013) also commented that the degree of impact on fisheries along the Taranaki coast, including the valuable rock lobster fishery and the developing shellfish fisheries, will depend on the amount of sediment that is introduced into the reef environment. They concluded that with appropriate management of sediment dispersal, no significant off-site impacts on commercial fisheries are anticipated. Since this assessment TTR has commissioned an assessment of the scale of marine ecological effects of seabed mining in the South Taranaki Bight by NIWA (MacDiarmid et al. 2015). It concludes that given the main area of distribution of rock lobster is close inshore in naturally turbid water, any displacement of lobsters or decrease in prey abundance or availability should have negligible effects on the state of the stock.

Mitigation measures recommended by Fathom Consulting Ltd (2013) included:

- Developing a contact list of companies and vessels operating in the area;
- Designing and implementing a communication system to alert vessel operators to the intended location and duration of iron sand recovery activities on a regular basis;
- Developing a more precise understanding of the location and seasonality of set net effort in the area of the operations, and designing the mining operational plan to minimise any impacts on the school shark fishery; and
- Undertaking the iron sand recovery operations in a manner that minimises the risk of sediment dispersal in the wider marine environment.

1.16.1 EPA Review Findings

The EPA commissioned AECOM to review Fathom Consulting Ltd (2013).

The review by AECOM concluded that the information presented in Fathom Consulting Ltd (2013) supports the conclusion that there would be no negative impacts on quota value, downstream businesses, or fish stock sustainability. This conclusion was based on the following assertions:

- The habitat that would be impacted has little particular fisheries value over and above similar habitat in the region; and
- That the impacted habitat is small compared to the wider habitat.

1.16.2 Joint Expert Conferencing Results

As part of the 2014 hearing, conferencing of commercial fishing experts took place on 20 March 2014. The experts all agreed that there will be localised and transient changes in the distribution and abundance of commercially important fish species in the immediate vicinity of the iron sand recovery operations that could result in changes to catch rates (either positive or negative). Experts were unable to agree on the scale of effects further away in Fisheries Management Area 8 (which extends from Plimmerton in the south to Waikawau in the north).

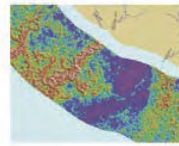

However, the experts all agreed that if the site had been in operation, the level of historical catch foregone across the 65.76km² project area would range from 0.001% to 1.658% of the fish stocks harvested from within the relevant quota management areas.

They also agreed that exclusion is unlikely to result in more than minor additional costs for fishermen (due to the small amount of displaced catch), and is unlikely to have a more than minor adverse effect on fishing operations, profitability, fish stock sustainability or quota value averaged across the whole relevant quota management areas.

GEOLOGY

1.17 TTR Report: Geological Desktop Summary Active Permit areas 50753 (55581), 54068 and 54272, South Taranaki Bight (Orpin 2013)

TTR commissioned NIWA to undertake an evaluation of geological information relevant to the project area. This factual report (Orpin 2013) evaluated NIWA's 50 year archive, comprising limited sediment samples, cores, and coverage by seismic reflection and side-scan sonar surveys in the South Taranaki Bight.

Orpin (2013) noted that in the South Taranaki Bight a shore-connected Holocene sand prism, up to 20m in thickness at the coast, extends seaward to around 20-30m water depth. The middle shelf is also covered by a sheet of gravel and sand, is commonly rippled by wave action and is draped with 1-3m of muddy sediment at > 50m water depth. At around 100m water depth, muddy deposits dominate the seabed and sub-seafloor.

Sediments containing >5% iron sand are largely spatially restricted to the inner and middle shelves. On the middle shelf, buried coarse-grained transgressive deposits that occur south of Patea and Whanganui could contain iron sand concentrations.

The limited suite of intact shelf cores archived at NIWA show that measured iron concentrations are variable, but typically increase down-core with a relative enrichment of iron sand in the shell gravel lag at the base. This trend appears to be less apparent nearer the shore.

1.17.1 EPA Review Findings

Orpin (2013) was not formally reviewed by the EPA, as it provided a factual report which was relied on by a range of other assessments commissioned by TTR.

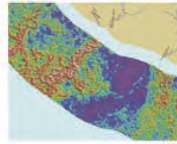
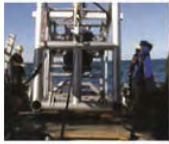

NAVIGATIONAL

1.18 TTR Report: South Taranaki Bight Marine Traffic Study (Marico Marine Ltd 2013)

TTR commissioned Marico Marine Limited to undertake a comprehensive study (Marico 2013) into marine traffic movements and navigational safety within the South Taranaki Bight in order to establish the impact of the iron sand recovery project TTR on shipping.

Marico (21013) reviewed 12 months of vessel movement records in the South Taranaki Bight. The results showed considerable variability in marine activity within the South Taranaki Bight, but that the project area has low levels of existing transit activity. There are very well demarcated shipping routes between major nodes, which contain the majority of dry cargo and liquid tanker traffic. This is particularly so between New Plymouth, Nelson and the Cook Strait, and these routes are well away from the proposed area of dredging operations. The activity of fishing vessels around the centre of the South Taranaki Bight is far more dispersed and accounts for a large proportion of the non-transit movements. There is a natural focus of offshore services around the oil and gas installations to the south west of the South Taranaki Bight.

Near project the traffic density was generally low to very low, with only a handful of vessels transiting through the site in the 12 month data period. The majority of vessels operating adjacent to the project area were engaged in servicing the Kupe gas rig operation.

A single shipping route between the Cook Strait and the Taranaki Bight was identified as adjacent to the proposed site, but was at a distance of five nautical miles. The disposition of traffic in that route was defined. Within this five mile distance, only 58 vessel movements were recorded in the 12 month period (approximately 1 movement every 6 days). Most of these transits were small dry cargo ships. There was shown to be both a low number of vessel encounters and vessel exposure, indicating a low risk of collision and plenty of sea room for vessels to navigate around the proposed iron sand recovery operations.

The results show that the proposed project area is located in an area of a very low traffic density and the iron sand recovery operations would have very little impact, if any, on the safety of navigation in the adjacent areas.

Given the low level of traffic, the operation could use standard marine watch-keeping systems to interface with other vessel traffic and based on the data, there is no need for any remote management of vessel traffic through the proposed site. The only vessels missing from this data set will be small vessels not fitted with AIS transponders. All vessels involved in the proposed iron ore extract operation are recommended to be fitted with AIS data transponders.

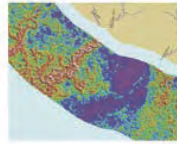

1.18.1 EPA Review Findings

The EPA commissioned North and Trew Ltd Marine Consultancy to undertake a review of various navigation-related reports prepared for TTR, including Marico (2013). The North and Trew Review found that Marico (2013) was sound in structure and useful in part, although its scope was limited and therefore its conclusion, that the iron sand recovery operations will occur in an area of low marine traffic, would not apply to some aspects of the operation, which were intended to be carried out elsewhere.

1.19 TTR Report: Report on the Maritime and Navigational Impacts of the Project (Barlow 2013)

TTR commissioned R N Barlow and Associates Ltd to prepare a report on the maritime and navigational impacts of the project (Barlow 2013). The key findings were:

- The project area is removed from regular marine traffic routes and activities and should not be in conflict with other marine traffic and activities in the area;
- An exclusion zone around the FPSO is unlikely to affect recreational opportunities in the project area as the Marine Traffic Study indicates that the area is very lightly used by any vessels. The site is also well removed from recreational boating launching and mooring sites;
- All the major vessels employed on the project will be classed by a member of the International Association of Classification Societies (IACS) and be compliant with the Safety of Life at Sea Convention (SOLAS) and all other International Maritime Organisation (IMO) Conventions as well as the Laws of New Zealand. Any other smaller vessels will be registered under the New Zealand Safe Ship Management System (SSMS);
- Biosecurity issues associated with the project essentially revolve around the management of ballast water and hull fouling of vessels arriving in New Zealand. All vessels arriving in New Zealand are required to make a 'Ballast Water Declaration' and comply with the 'Import Health Standard for ships ballast water from all countries' issued under Section 22 of the Biosecurity Act 1995. In addition, arriving vessels will be required to meet the 'Craft Risk Management Standard (CRMS) for Biofouling on Vessels arriving to New Zealand' issued under section 24G of the Biosecurity Act 1993;
- Operational discharges will comprise of sea water used for cooling machinery and products of combustion from engines and turbines. Sewage and garbage will be dealt with as required under MARPOL Annex IV and V;
- All oils will be retained on board for disposal ashore at an approved facility;
- Any hazardous materials will be retained on board for disposal ashore at an approved facility; and

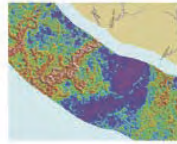
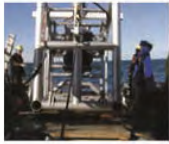

- The project is likely to use a number of different ports to support the vessels engaged in the project depending on the services required and the method of delivering them. The ports of Whanganui, New Plymouth and Nelson are the closest to the project area in that order, and each may offer the project support in different ways according to their capabilities.

1.19.1 EPA Review Findings

The EPA commissioned North and Trew Ltd Marine Consultancy to undertake a review of various navigation-related reports prepared for TTR, including Barlow (2013). The North and Trew Review found that Barlow (2013) adequately covered most of the maritime and navigational aspects of the project, but that it failed to provide a sufficient level of detail in respect of marine vessel operations and transfer operations.

The two gaps were addressed in detail in the Joint Expert Conference discussed below.

1.19.2 Joint Expert Conferencing Results

Expert conferencing of the Navigation Safety experts took place by telephone between 13 March 2014 and 26 March 2014. This conference jointly addressed information in Marico (2013) and Barlow (2013).

The following facts were agreed:

- That it is reasonable to assume that all other vessels contracted or employed for bunkering and the associated engineered systems will be of relatively recent design and will comply with internationally recognised standards and codes;
- That the system designs should be informed by international best practice in bunker fuel handling, formal risk analysis and assessment and incorporate all reasonably practical measures to enable safe bunkering and fuel transfer operations of high integrity;
- The operating procedures for fuel transfers should be incorporated in the 'Project Safety Case' and be approved by Maritime New Zealand;
- Hydrodynamic Studies should be undertaken for transfer operations to ensure the operating procedures and Upper Operating Limits are properly determined during the risk analysis and HAZOP studies;
- That hydrodynamic studies will be undertaken for transfer operations to inform the design of the vessels and transfer equipment and systems and safe operating limits;
- That the system designs will be informed by contemporary international best practice, formal risk analysis and assessment, and incorporate all reasonably practical measures to enable vessel and mining operations to be of high integrity and safe;

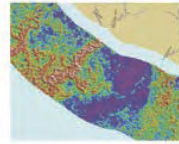

- An interpretation of the Maritime Transport Act 1994 (provided by Maritime NZ to the EPA as part of this hearing process) places into doubt MNZ's interest in overseeing product transfer operations, as it differentiates between this and tanker-to-tanker transfers (bunkering). It further differentiates between bunkering and tanker to installation transfers although it does not make clear what interest it has in the latter operation;
- That all transfer vessels will carry fuel and personnel and therefore all transfer operations carry an inherent level of risk, which could be increased if the site for such transfers is ad-hoc;
- There is a current transferral of particular MTA responsibilities to the EPA, and a level of uncertainty as to where some responsibilities will ultimately lie. Any uncertainty can be satisfactorily resolved or managed by ensuring that the conditions of any consent granted include mechanisms for ensuring approval and monitoring of both the locations of the transfer operation and the operation itself is required. This is necessary to ensure a safe operation and to minimise the risk to other shipping and the environment;
- In addition to prevailing and forecast meteorological conditions, transfer operations carried out away from the project area must be undertaken in a manner that does not create a navigation hazard to shipping and occurs out of recognised shipping routes. The Marico (2013) study should provide guidance in selecting areas;
- Transfer operations should be undertaken with the receiving vessel at anchor or under dynamic positioning system or making steerageway only;
- The project operations manuals and contingency plan should be constructed around a comprehensive 'Project Safety Case' which should be applied to all project operations;
- The Project Safety Case' should also provide the basis for applications to Maritime New Zealand for fuel and product transfer operations at sea as required under the Marine Protection Rules Part 103; and
- A set of agreed conditions were developed to satisfy navigational safety concerns.

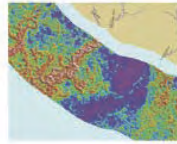
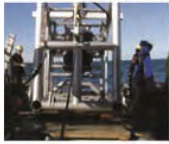

NOISE

1.20 TTR Report: Assessment of Noise Effects (Hegley Acoustic Consultants 2013)

TTR commissioned Hegley Acoustic Consultants Ltd in 2013 to prepare a report on the noise effects from TTR's proposal, and the potential effects of any associated noise on marine mammals in the area (Hegley 2013). The key findings were:

- The underwater noise from the crawler operating has been predicted at typically 130dB at 200m, 121dB at 500m, 115dB at 1km and 108dB at 2km (all sound levels expressed as "re 1 μ Pa"). Estimates are based on an operational depth of 30-40m;
- The noise level from the IMV (including the generators to power 80 MW of machinery) will be typically 188dB at 1m when transiting. The IMV is a smaller vessel and will have a predicted level of typically 185dB at 1m when transiting and the Anchor Handling Tug will be typically 170dB at 1m (all sound levels expressed as "re 1 μ Pa");
- No hearing hazard or communication masking for marine mammals is anticipated from the proposed iron sand recovery operations. Therefore, no change to the migration or lifestyle of dolphins or whales due to noise is anticipated;
- If marine mammals are close to the dredging (approximately 50m) the environment will be noisy at 47dB above the threshold of hearing. However, these levels are not believed to be sufficient to cause any unacceptable disturbance for marine life; and
- There is no past evidence of any adverse effects of noise for marine mammals in the area from the existing shipping lanes, and therefore the shipping activities will not cause adverse noise related effects.

1.20.1 EPA Review Findings

The EPA commissioned URS New Zealand Limited to undertake a review of Hegley (2013). The URS review found that:

- Hegley (2013) does not consider the availability of any national or international guidance on marine mammals and underwater noise impacts;
- The noise assessment does not consider the duration of the works, specifically the 20 year expected project life and the 24/7 operations;
- The assessment of noise has considered likely levels of source noise, propagation of noise and the assessment of effects. Noise level information has been provided, but there is a lack of cross referencing;
- Hegley (2013) has extrapolated the dredge in air sound power level to an underwater level without stating how the calculations have been performed;
- The individual noise sources present in the project area will combine to produce higher noise levels (i.e. combined noise from dredging and vessel noise). Cumulative noise has not been considered in the study; and

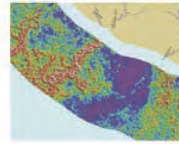
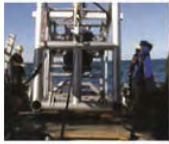

- Hegley (2013) has used historical data to determine whether marine mammals will perceive noise from iron sand recovery operations and whether behavioural effects will occur.

1.20.2 Joint Expert Conferencing Results

Expert conferencing of experts in the fields of marine mammals and noise took place on 19 March 2014. This conference jointly addressed information in Hegley (2013) and supplementary information provided in response to the information gaps identified in the URS review.

In respect of noise, there was no agreement among the experts on the noise levels and frequencies produced by the proposed operation or the sound propagation models.

It was agreed that it would not be appropriate to rely solely on a condition that required management action in response to observed changes in marine mammal behaviour.

The experts agreed that setting a noise limit at a distance from the operation is an appropriate management approach, and in setting such noise limits it was important to consider not only the sound level but also the frequency spectra of any noise. The group was unable to reach agreement on a sound level or distance to use as a condition.

Note: With one exception (who was not in fact a specialist in marine noise), all experts agreed that the following would represent an appropriate noise condition:

The consent holder shall comply with the following requirements in relation to underwater noise:

- a) The combined noise from the FPSO and Crawler operating under representative full production conditions shall be measured nominally 10m below the sea surface at 300m, 500m, 750m and 1000m from the port or starboard side of the FPSO. The combined noise level at 500m shall not exceed 130dB re 1 μ Pa RMS linear in any of the following frequency ranges: low frequency 10-100 Hz, mid-frequency 100-10,000 Hz, and high frequency >10,000 Hz; and the overall combined noise level at 500m across all frequencies shall not exceed a sound pressure level of 135 dB re 1 μ Pa RMS linear; and*
- b) Measurements shall be undertaken in calm sea conditions (e.g. Beaufort sea state less than 3 (beginning of white-capping)), with no precipitation and no external noise sources (e.g. passing ships).*

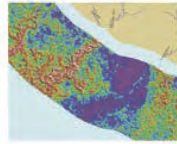
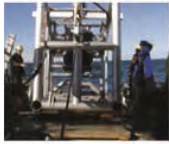

OCEANOGRAPHIC INFORMATION

1.21 TTR Report: South Taranaki Bight Iron Sand Mining: Oceanographic Measurements Data Report (MacDonald et al. 2013a)

TTR commissioned NIWA to undertake a field programme to measure currents, waves and sediment transport in the South Taranaki Bight. The primary goal of the field programme was to collect an oceanographic data set that would support the development by NIWA of numerical models of current flows, waves and suspended-sediment plume dispersion in the South Taranaki Bight. Studies were undertaken between September 2011 and July 2012, and included an extreme weather event (3 March 2012).

The report on these investigations (MacDonald et al. 2013a) presented a synthesis of the oceanographic field measurements with the following main findings:

- Tidal currents account for a significant proportion of the measured currents at all sites. The peak ebb or flood current speed ranged between 0.13m/s and 0.25m/s. Somewhat higher and lower tidal speeds occur on spring and neap tides respectively. At all sites the tide was oriented in the southeast - northwest direction (parallel with the coastline). The presence of such tidal current speeds well offshore in the South Taranaki Bight was found to arise from the alternate flow of water over the extensive, relatively shallow, shoals off Hawera and Patea;
- Currents in the South Taranaki Bight were also found to be substantially affected by wind conditions with large current speeds of around 1m/s measured on a number of occasions during periods of high winds. Winds blowing from the west and the southeast sectors had the most pronounced influence on currents. Moderate to strong winds not only increased current speeds, but also greatly altered current direction. During strong winds, currents could set in a constant direction for more than 24 hours. During calm conditions currents reversed approximately every 6.2 hours with the tides re-asserting dominance;
- At most sites during periods of light winds the prevailing current drift was towards the southeast, which is consistent with the influence of the D'Urville Current - which sweeps past Farewell Spit and turns around in the South Taranaki Bight to head south. However, current drift directions were significantly altered by moderate to strong southeast winds, which reversed the drift towards the northwest. During times of moderate to strong west to northwest winds, the prevailing southeast drift was considerably enhanced;
- Wave data clearly showed that the South Taranaki Bight is a high-energy environment. At the deep sites, significant wave heights in excess of 4m were routinely observed. The highest significant wave height of 7.1m was recorded on 03/03/2012 at 05:40 during an extreme weather event in South Taranaki;

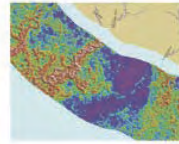
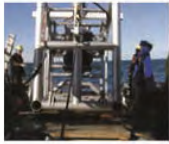

- Waves greater than 2m in height arrived mainly from either the south – south - southeast or from the southwest – west-southwest sectors. There was a reduction in wave height moving from the offshore deeper sites into the shallower sites close to the shoreline, which is part of the wave shoaling process. There was also a reduction in wave height moving down coast in a south - southeast direction, caused by sheltering of the prevailing southwest to west-southwest swell by Farewell Spit;
- Temperature and salinity measurements show that the water column in the South Taranaki Bight was generally well mixed. Slightly lower salinity is likely to be found in the vicinity of major rivers in the South Taranaki Bight (e.g., Patea, Waitotara and Whanganui);
- In the near-surface waters, the maximum suspended-fine-sediment concentration (SSC) was 0.025 grams/litre. At some sites SSC varied over the deployment period, with peaks in SSC tending to occur during or just after periods of significant rainfall. At these times it is likely that rivers were discharging fine sediments into the South Taranaki Bight, which were then being transported in suspension through the measurement site. Some of the peaks in SSC also coincided with times of large waves;
- The largest suspended-sand concentration very close to the seabed was 1.9 grams/litre. At all sites, periods of increased sand concentration coincided with periods of large waves, thus highlighting the importance of waves in re-suspending sand from the seabed in the South Taranaki Bight. During calm periods, no sand was found to be in suspension; and
- Over the duration of the largest sediment-transport event, 3,355kg of sand per metre width of seabed was transported in suspension by currents. This equates to a volume of 2.1 m³ of sand transported per metre width of sea bed. These are gross transport rates in any direction.

1.22 TTR Report: Nearshore Optical Water Quality in the South Taranaki Bight (MacDonald et al. 2013b)

TTR commissioned NIWA to undertake a field programme to measure background optical water quality and suspended sediment concentrations (SSC) in the nearshore region (within 2.5km of the shore) of the South Taranaki Bight. The field studies were undertaken to provide background details to help assess the potential effects of offshore sand extraction on the surrounding environment, in particular the effect of sediment plume dispersal.

The report on these investigations (MacDonald et al. 2013b) presented a synthesis of the oceanographic field measurements, with the following main findings:

- Measurements from nearshore boat surveys showed that SSC and optical variables vary significantly with distance offshore, with SSC and diffuse light attenuation being greatest closest to the shore, and visual clarity increasing rapidly with distance offshore;
- There appears to be a reduction in SSC (and hence an increase in visual clarity) moving down the coast in a south - southeast direction;

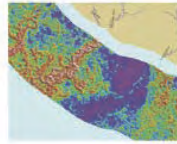
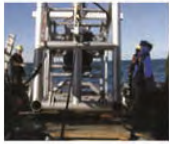

- During the last two weeks of the deployment period there was a significant increase in SSC, coinciding with increased river flows. At these times it is likely that the rivers were discharging fine sediments into the South Taranaki Bight, which were then being transported in suspension through the measurement site. Some of the peaks in SSC also coincided with times of high wind speed but low river flows. These peaks in SSC are most likely wave-driven. At these times, wave stirring is entraining fine sediments from the sea floor, which are subsequently mixed into the water column;
- During river and wave events, less than 1% of the ambient light is reaching the seabed benthos;
- The deployment took place during a period of lower than expected rainfall for that time of year, and consequently during a period of low river flows. Since rivers are a major source of fine sediments into the South Taranaki Bight, it is likely that the data are representative of conditions with clearer water; and
- Overall, the field dataset provides a comprehensive picture of the background optical water quality and SSC in the South Taranaki Bight. These results can be used with confidence to help assess the potential effects of offshore sand extraction on the surrounding environment, and in particular the effect of sediment plume dispersal in the nearshore environment.

1.22.1 EPA Review Findings

EPA commissioned SKM to review reports relating to the effects on the physical environment. These included MacDonald (2013a) and MacDonald (2013b). The SKM review found that the description of the existing environment is generally comprehensive, despite there being little published information about the study area and its environmental values. They noted that the applicant has undertaken extensive field investigations to assist in describing the environmental values of the project area and referred to published literature where it is available. There is also significant breadth in the analysis of existing environmental values, with consideration of a diverse range of issues affecting the coastal zone and oceanographic processes.

1.22.2 Joint Expert Conferencing Results

Expert conferencing of experts in the field of effects on bathymetry and oceanographic process took place on 20 March 2014. Among other matters, this conference addressed information in MacDonald (2013a) and MacDonald (2013b).

In regard to oceanographic measurements, all experts agreed that the oceanographic measurements are fit for purpose and to international standard. They identified no areas of disagreement, and they identified no areas of uncertainty beyond the normal measurement error and natural variation implicit in any field measurements.

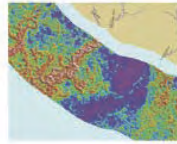
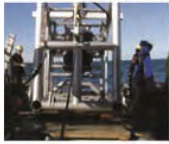

OTHER MARINE MANAGEMENT REGIMES

1.23 TTR Report: Other Marine Management Regimes Assessment (Boffa Miskell 2013)

TTR commissioned Boffa Miskell Limited to undertake an assessment of the project against the statutory provisions of other marine management regimes considered of relevance under the EEZ Act. This assessment (Boffa Miskell 2013) evaluated the way in which TTR's Impact Assessment documentation had given consideration to these statutory provisions, and concluded that the full effect of these statutory provisions had been addressed.

It was further considered that project will not be inconsistent with any of the relevant provisions in the 'other marine management regimes' assessed.

1.23.1 EPA Review Findings

Boffa Miskell (2013) was not subject to a specific peer review by the EPA, but was evaluated by staff directly, with further information requested under s42 of the EEZ Act in relation to the following matters:

- Further information on how vessel design and safety information will be compiled and delivered to the relevant agency / agencies;
- Further information on how vessel design and safety information will be compiled and delivered; and
- Detail of the 'result' or 'effect' of other management regimes in relation to the nature of the activity that will take place and the effects of the activity that will take place? In particular in relation to:
 - Maritime NZ oil spill contingency planning requirement.
 - Maritime NZ requirements for flagging and the classification body of the FPSO and other vessels.
 - Maritime NZ requirements which will impact on the movements of the ancillary vessels.
 - Health and Safety Act requirements
 - The effect of any other marine management regime which influences the nature of the activity or the effect of allowing the activity
 - The extent to which imposing conditions might mitigate adverse effects

TTR provided this information to EPA in February 2014, which was satisfied enough to proceed with the hearing process.

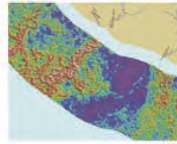
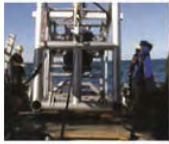

1.23.2 Joint Expert Conferencing Results

No joint expert conference specifically addressed Boffa Miskell (2013). However, on 18 March 2014 a joint conference was held among experts on the development of conditions in mitigation of adverse effects. At this conference the experts agreed that RMA best practice and quality planning principles apply in the context of setting of conditions and that adaptive management is an appropriate approach in the context of the application (*as applied for in 2013 / 2014*).

RECREATION

1.24 TTR Report: Recreation and Tourism Assessment of Effects (Greenaway and Associates 2013)

TTR commissioned Greenaway and Associates in 2013 to identify the recreation and tourism activities which occur in the area that is potentially affected by the project. Greenaway (2013) found as follows:

- The regionally important coastal marine recreation settings in the study area are based at the main public access and activity points: Ohawe Beach, Waihi Beach, the mouths of the Tangahoe and Manawapou Rivers, Patea, Waipipi, Waiinu, Kai Iwi and Castlecliff, and the fishing and cray-fishing resource up to 20km offshore. The level of shellfish gathering along the coast is unclear, but is a locally important activity;
- The section of coast extending from Patea to Cape Egmont is relatively lightly fished in comparison with the coast south of Patea and in North Taranaki. Very little recreational fishing occurs more than 20km offshore along the entire west coast of the North Island;
- Tourism activity in the study area is largely limited to the six beach camp sites and three fishing charter operations – two operating from Patea and one from Whanganui; and
- Potential effects of the project of interest to the recreation and tourism community are, as identified from concerns expressed at public meetings and interviewees contacted for this report, and review of technical data prepared for TTR:
 - Turbidity effects (underwater visibility and smothering of biota) and the location of the sediment plume and sediment effects on onshore and offshore reef systems;
 - Re-suspension of returned sand during storm events or other wave action and the potential for long-term turbidity issues;
 - Re-colonisation rates for biota in the project area;
 - Toxicity of returned sand and effects on biota throughout the study area;
 - Changes to coastal wave patterns affecting surfing opportunities;

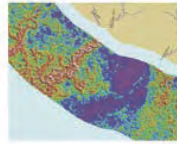
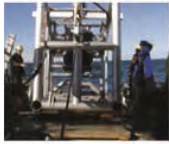

- 'Sand budget' effects on the replenishment of beaches and sand bars (also an issue for surfing);
- Exclusive use of the marine area in the project area and interference with navigation routes for recreation craft; and
- Effects on the environmental ('clean green') reputation of New Zealand.

Review of relevant technical reports indicates the following potential scales of effect:

- Potential adverse effect on recreation and tourism due to changes to water clarity are:
 - Minor in the inshore marine setting where most recreational activity occurs due to the very low scale of effect on water clarity in the inshore environment and the high level of background suspended sediment;
 - Minor in the important diving setting of the Traps due to a persistent but small scale change in water clarity, which will be most apparent only when the iron sand recovery activity is occurring in the eastern part of the project area (that is, not for the full period of mining activity);
 - However, there is potentially a moderate scale of effect in water clarity at the Traps during the rare periods of extreme water clarity (>10m horizontal visibility on the bottom for four days per year), which are likely to coincide with ideal settled diving conditions and are therefore likely to be experienced by divers seeking a scenic experience, and when water clarity is marginal (<5m) for divers hunting crayfish. Similar effects are also likely at the less important diving setting on the Graham Bank; and
 - Minor on the offshore surface recreation experience in the South Taranaki Bight (fishing, sailing and other boating), due to the large scale of the offshore setting, the relatively low level of activity in the plume area and the transient characteristic of the experience.
- Potential adverse effect on recreation and tourism due to changes to marine ecology are:
 - Minor on recreation and tourism in the mining area due to very low levels of use of the setting and the large scale of alternative and proximate activity areas, although site-specific effects on benthic marine organisms will be greater; and
 - Minor for recreation and tourism activities outside the mining area due to the low scale of adverse effects on marine ecosystems.
- There is also:

The potential for only minor, if any, effect on surfing, and inshore recreation which relies on natural beach replenishment processes, due to the very low scale of potential adverse effect ('insignificant' changes to wave patterns and only a very weak potential link between the mining setting and inshore sediment levels);

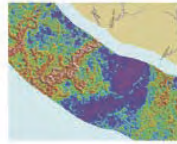

The potential for only very minor effects on recreation and tourism in the South Taranaki Bight due to exclusive occupation of the marine environment as proposed due to the very small area occupied by the activity; and

Very little potential for adverse effects on New Zealand's tourism brand as the mining activity has limited adverse environmental effects and occurs well away from internationally and nationally important tourism settings.

Greenaway (2013) concluded that adverse effects of interest to recreation and tourism are therefore likely to be largely local to the iron sand recovery activity, and will relate to exclusive use of the marine setting, local turbidity effects (up to 10km from the site) and short-term effects on habitat in recently mined seafloor. The main recreation effects of interest are on diving at the North and South Traps. Adverse turbidity events will be limited to the periods when mining occurs in the eastern part of the mining area and may influence recreation satisfaction when water clarity would normally be extreme (approximately four days per year) and when diving is marginal for crayfishing, with 19 more days of visibility below 2m in a year with proximate mining activity. Similar effects will occur at the less important diving setting on the Graham Bank.

1.24.1 EPA Review Findings

The EPA commissioned Market Economics Limited (ME) to undertake a peer review of the potential effects on recreation associated with the project. The ME review was satisfied that Greenaway (2013) had addressed the recreation activities that could be affected by the project. However, ME noted that an assessment of recreation activities potentially affected if operations do not go as intended was omitted.

1.24.2 Joint Expert Conferencing Results

On 18 March 2014, a joint conference was held among experts on social, recreation and tourism impacts. At this conference the experts agreed that the EPA would be assisted by the provision of additional data describing the scale and role of tourism and recreation activity in the South Taranaki area. These data were appended to the joint witness statement, and were intended to 'set the scene' more clearly. However, it was agreed that the data on tourism and recreation activity is not sufficiently detailed to be used as a baseline against which effects of the proposal in its intended operation could be measured.

The witnesses also agreed that a major oil spill or other disaster (unintended outcome) has the potential to have significant adverse effects on coastal recreation and tourism. It was agreed that direct effects specific to businesses and recreation groups could be identified (at the time of the disaster).

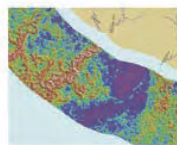

SEDIMENT TOXICOLOGY

1.25 TTR Report: Iron Sand Extraction in South Taranaki Bight: Effects on Trace Metal Contents of Sediment and Seawater (Vopel et al. 2013)

TTR commissioned Auckland University of Technology (AUT) in 2013 to investigate the following aspects as a function of depth below the seafloor:

- (1) Selected physical properties of the target sediment;
- (2) The sediment content of acid volatile sulfides and simultaneously extracted trace metals; and
- (3) The concentrations of trace metals in suspensions of sediment in seawater.

TTR also contracted AUT to investigate if grinding enriched iron sand increases the potential of this sand to release trace metals when suspended in seawater.

AUT's report on the findings of these studies (Vopel 2013) concluded as follows:

- No evidence for an increase with depth below the seafloor in sediment organic matter and acid volatile sulphides (AVS) contents;
- Concentrations of acid-extracted cadmium, copper, lead and zinc in deep sediment were of the same order of magnitude as their maximum concentrations in surface (reference) sediment;
- The sediment concentrations of acid-extracted lead decreased with depth below the seafloor at three of five sites;
- Low probability of adverse effects of these dilute-acid soluble metals on benthic ecosystem functioning; and
- Concentrations of acid-extracted chromium and nickel in deep sediment were often one order of magnitude higher than their maximum concentrations in surface (reference) sediment. At four of five sites, acid-extracted chromium and nickel concentrations increased with increasing depth below the seafloor.

For all metals except nickel, the concentration in seawater suspensions of deep sediment were either below detection limit (chromium, copper, lead, zinc) or, if a metal was detected (cadmium), the concentration did not exceed the ANZECC & ARMCANZ guideline for the protection of 99% of species. The detection limit of copper was below the guidelines for the protection of 95% of species.

The concentrations of nickel in the seawater suspensions of deep sediments (all five sites) and surface (reference) sediment (three of five sites) were equal or larger than the ANZECC & ARMCANZ guideline concentrations for the protection of 99% of species. However, the nickel concentration never exceeded the guideline concentrations for the protection of 95% of species.

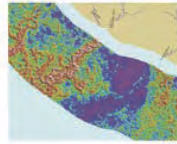
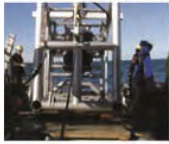

Assuming that the nickel concentration in South Taranaki Bight seawater equals the detection limit for nickel, it would only require an 83-fold dilution of the elutriate extract to decrease the highest nickel concentration measured to below guideline concentrations for the protection of 99% of species.

Tests to investigate if grinding of iron sand will increase trace metals concentrations in the seawater revealed concentrations of cadmium, lead and nickel below the limits of reporting for all sediment samples. Chromium was detected in relation to the finely ground sediment fraction; and zinc was detected in relation to all grinding sizes. For both metals, the concentration averages for each sand size fraction did not exceed the ANZECC & ARM CANZ guideline for the protection of 99% of species. Vopel (2013) inferred a low probability of adverse effects of these metals on ecosystem functioning of the South Taranaki Bight water column.

The concentration of copper in seawater suspensions of iron sand concentrate increased with finer iron sand particles, exceeding the ANZECC & ARM CANZ guideline for the protection of 99% of species. A 160-fold dilution would decrease these concentrations to below the concentration limit for the protection of 99% of species.

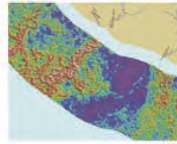
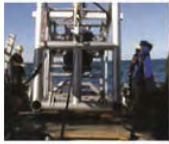

1.25.1 EPA Review Findings

The EPA commissioned SKM to undertake a peer review of Vopel (2013). SKM found that the methodology of Vopel (2013) was generally appropriate, however they would expect the trace metal analytic list to include mercury, given that volcanic activity, the source of the iron sand deposits, is also a significant source of mercury in New Zealand.

TTR provided supplementary information in relation to mercury in response to this query. The review also requested additional information on immediate mixing of sediment plume metal levels within the near-field discharge. Again, TTR subsequently provided this information to the EPA.

1.25.2 Joint Expert Conferencing Results

Expert conferencing of experts in the field of effects on benthic ecology took place on 19 and 21 March 2014. Among other matters, this conference addressed information in Vopel (2013).

The experts agreed that concentrations of nickel and copper in the discharged seawater were unlikely to negatively affect the re-colonisation of the seabed, based on the updated information provided at the conferencing session. The experts agreed with the SKM reviewer in their recommendation to include analyses of mercury in any water quality monitoring programme until the expectation that the recovered sediment will not release mercury was confirmed.

The experts recommended monitoring of trace metals and other water quality variables that affect the bioavailability of trace metals (e.g., pH and dissolved oxygen) for the lifetime of the iron sand recovery operations in a) the seawater stream onboard the processing vessel, b) the discharged seawater stream in the vicinity of the outlet (distance to be determined), and c) the unaffected South Taranaki Bight seawater (background control).

SHORELINE PROFILE

1.26 TTR Report: Shoreline Monitoring Data Report (MacDonald et al. 2012)

TTR commissioned NIWA to undertake an 11-month beach monitoring programme along the South Taranaki Bight. The purpose of the monitoring was to provide background data, from which rates of change along the shore (shoreline stability) could be established, before the commencement of any offshore sand extraction.

A network of 32 beach profiles at 8 sites was established to monitor the shoreline stability along the South Taranaki Bight from Kai Iwi to Ohawe. The sites were selected as lying landward of the project site, away from rivers and headlands which may influence beach processes locally and where there was public access to the beach.

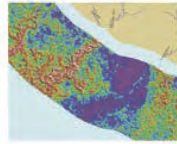
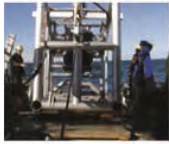

MacDonald (2012) described the methodology used in measuring the beach profiles and presented results from 11 surveys that measured 352 profiles (100% data capture) over an 11-month period from June 2011 to April 2012.

One of the 11 surveys was carried out immediately after a storm. The relative accuracy of the survey data was at worst deemed to be around 6cm in the horizontal and 3cm in the vertical. This level of accuracy was more than sufficient for the purposes of measuring changes in beach profiles. The beach profiles show that the shoreline along the South Taranaki Bight is very dynamic, with large changes in the beach profiles occurring at nearly all of the 32 profiling sites. At 6 of the 8 sites, there is little accommodation space for beach sand which appears to form a veneer only several metres thick over the rocky shore platform left by the retreating cliff line. Very high tides and waves reach right to the top of the beach and the toe of the cliffs, thus there is no space for sand dunes to build out of the reach of waves. Given the limited storage, potentially a large fraction of the entire beach volume is being washed off and on shore on a regular basis.

In addition to the beach profiles, on a single occasion, surface sediments were collected around the mid-tide mark at each of the profiles. The results of the sediment analysis showed that the majority of the surface sediments could be described as either moderately-sorted-slightly-gravelly sand or poorly-sorted-gravelly sand. At some sites, significant differences in sediment characteristics exist between profiles. Typically, gravel contents were less than 10%, except at Hawera which had gravel contents at all 4 profiles in excess of 20% and as high as 66%.

1.26.1 EPA Review Findings

The EPA commissioned SKM to undertake a review of MacDonald (2012). The review found that MacDonald (2012) provides new data on shoreline dynamics that represents best available information.

1.26.2 Joint Expert Conferencing Results

Expert conferencing of experts in the field of effects on coastal processes took place on 20 March 2014. Among other matters, this conference addressed information in MacDonald (2012) and concluded that shoreline profile monitoring measurements were fit for purpose and to international standard.

The experts identified no areas of disagreement, nor areas of uncertainty beyond the normal measurement error and natural variation implicit in any field measurements.

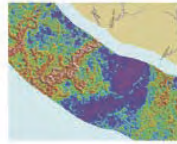
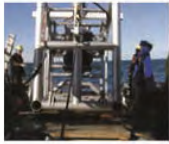

SOCIAL EFFECTS

1.27 TTR Report: Social Impact Assessment of Trans-Tasman Resources Ltd Iron Sand Mining Project (Corydon Associates Ltd 2013)

TTR commissioned Corydon Consulting Limited in 2013 to assess the social impacts of the project on local communities and identify possible mitigation measures (Corydon Associates 2013).

Corydon Associates (2013) noted that TTR's operations will be supported by onshore services operating from Port Taranaki and Port of Whanganui, and offices in New Plymouth and Wellington. The communities potentially affected by the project are therefore spread across a large geographic area, with different communities and groups potentially affected in different ways.

Corydon Associates (2013) concluded that:

- It was unlikely that new jobs directly created by the project would address the relatively high levels of unemployment in the Taranaki area because of the specialised skill levels that will be required for most of the new positions. However, there could be increased opportunities for residents of South Taranaki and Whanganui to access training and work experience that is relevant to the range of positions associated with TTR's operations;
- The project would benefit businesses that provide services or supplies for the various aspects of TTR's operations. This will have a positive spin-off in terms of jobs and income for the communities in which these businesses are located, as well as increasing the viability of these businesses. It is anticipated that the majority of these benefits will accrue to businesses in the "wider area", particularly in New Plymouth, which already have experience in servicing extractive industries including those offshore;
- The direct creation of approximately 250 jobs will result in higher standards of living (and hence social wellbeing) for the households concerned. If many of these jobs are undertaken by workers who live locally, the project will help to offset the lower than average household incomes that are currently experienced in the profiled areas. Therefore, it is concluded that the project will create positive social effects as a result of the opportunity for higher than average livelihoods and financial support for the employees and their households; and
- The project is estimated to create a workforce of approximately 250 people. If all these workers were new to the area/region and they bring family with them, this could lead to an increase of approximately 625 new residents. However, because the land-based aspects of the proposed operations are spread across Taranaki, Whanganui and Wellington, and because of the nature of the shift-work rosters, it is likely that the workers and their families will be spread over a relatively large geographic area.

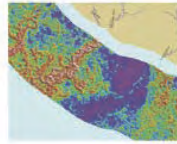
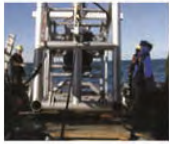

1.27.1 EPA Review Findings

The EPA commissioned Market Economics Limited (ME) to undertake a peer review of the potential effects on social impacts associated with the project. The ME review was satisfied that Corydon Associates (2013) had adopted a clear assessment methodology and framework for social effects assessment. It was recommended that more recent census data could be used but they considered that the use of such more recent data would not change/enhance the profile of the communities that was presented in Corydon Associates (2013).

1.27.2 Joint Expert Conferencing Results

On 18 March 2014, a joint conference was held among experts on social, recreation and tourism impacts. Matters related to the social impact of the iron sand recovery activities were not the main focus on the conferencing – which centred on tourism / recreation data and the potential for the project to affect New Zealand’s international tourism reputation.

VISUAL EFFECTS

1.28 TTR Report: Seascape, Natural Character & Visual Effects Assessment (Boffa Miskell Ltd 2013b)

TTR engaged Boffa Miskell Limited in 2013 to investigate and review natural character, landscape/seascape and visual amenity matters with respect to the potential effects of the project.

Boffa Miskell (2013b) provided a detailed evaluation of the effects of the project on seascape, natural character and visual amenity. Effects were categorised as follows: Visual effects from specific viewpoints and viewing audiences; effects on natural features and natural landscapes (being defined and/or special or significant landscapes/seascapes and features); effects on natural elements, natural patterns and natural processes (the natural character of the coastal environment).

Boffa Miskell (2013b) concluded that:

- While the visibility of the IMV will be high from marine areas within 10-15km of the vessel itself, the visual effects are assessed as being low overall and are unlikely to be perceived as being visually intrusive or adverse. Even though the IMV is large and its associated and smaller support vessels will also be present, and in some cases may be visible from the coastline for extended periods of time, the surface marine activities associated with the project are considered to be minor overall and where visible, will likely be seen as an “appropriate” working seascape activity;

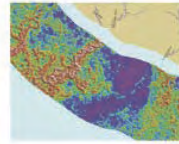

- While visibility from aircraft has not been specifically modelled, it is likely that these occasional and intermittent views will not be significant and the operational vessels will likely be viewed as a focal point and feature in the seascape;
- For all coastal areas along the South Taranaki Bight, the visibility of the Project will vary and in general, and where visible, will be seen as a distant and background offshore activity within an expansive seascape setting. The visual effects of the surface marine activities are assessed as being minor and will not be adverse nor will they appear to be visually intrusive from important recreation and amenity areas;
- While navigational lights can be on permanently or intermittently, it is unlikely the navigational lights, in most instances, would be visible from the coastline. Operational safety lighting will be continuous and will be more apparent from coastal locations due in part to its extent, its elevation and the need to adequately ensure safe on board operational activity. Under favourable weather conditions it is likely to be visible from some coastal locations in the Patea to Hawera area. There are however, few public roads or residences located on the coast where operational lighting will be seen to be particularly or intrusively visible;
- Areas of outstanding coastal values within South Taranaki Bight were assessed as showing relatively minor, if any effect from the project;
- Visual effects of sediment plumes from recreational boats will be evident and highly variable depending on weather conditions and the offshore location of the vessels. There will however be observable visual effects in terms of surface sea colour change and pattern in the distant offshore waters in the immediate vicinity and to the east of the mining activity in what is currently a dark blue-green water area. The colour range within the plume is likely to range from dark blue-green to a lighter blue-green colour extending over a distance of some 35-40km to the east of the mine site. From this point, which is approximately 10-15km offshore, the plume then becomes a “milky” colour until it blends into the background offshore levels to the east off Wainui Beach to a more brown-green colour as it extends towards the Whanganui River mouth area. *[It is noted that this conclusion will be revised in light of the updated sediment plume and optics modelling that has been undertaken in 2015];*
- While the size and pattern (scale) of the sea surface colour change is extensive and significant in its seascape context, its significance in terms of recreational/amenity values is likely to be lower, given the relatively low levels of recreational activity that occur within the affected marine area. Notwithstanding this, the visual effect of the TTR-derived sediment plume is considered to be moderate to high overall from marine based locations within or in close proximity (3-5km) of the plume. The sediment plume will however, only be evident during the extraction operations and accordingly this effect in the blue-green marine area is reversible; and

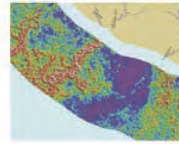
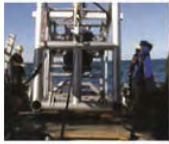

- Visual effects will be most apparent from recreational and commercial aircraft, and while these effects will be variable and dependant on weather conditions, they will tend to be experienced by transient viewers who in many instances will have no direct relationship with the area. In many instances, the visibility and the offshore pattern of the mining derived sediment plumes are likely to be seen as a feature and focal point in the South Taranaki Bight seascape. While the overall appearance and scale of the mine derived sediment plume will be most apparent from aircraft, given the characteristics of the viewing audience, the visual effects are assessed as being generally in the low to undetectable or observable range.

In terms of visible cumulative effects, the mining derived sediment will not add appreciably to the natural or background levels within the inshore and nearshore marine areas. There will however, be increased visual effects in terms of the offshore and distant offshore marine areas where currently there are no visible sediment plumes under most conditions. From the coastline cumulative effects are not likely to be particularly visible. From some marine areas, cumulative effects may be apparent, however, given the limited extent of views and the variability of the plume, cumulative effects are not likely to be perceived as being significant or adverse. From aircraft cumulative effects will be most apparent and are likely to be widespread in extent.

Effects on natural character were found to be minor, other than in relation to the plume near the operational area where effects were deemed to be low.

1.28.1 EPA Review Findings

The EPA commissioned SKM to undertake a review of Boffa Miskell (2013b). SKM accepted Boffa Miskell (2013b) conclusion that effects on natural features and landscapes are assessed as low, due to the distance of mining activities offshore, away from outstanding natural features of the coastal environment.

1.28.2 Joint Expert Conferencing Results

Boffa Miskell (2013) was not subject to a joint conference analysis. The findings were not disputed at the hearing.

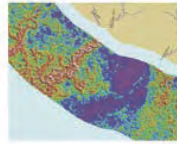
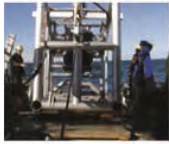

WAVE AND SURF EFFECTS

1.29 TTR Report: Nearshore Wave Modelling Phase 4 Studies (Gorman 2013)

TTR commissioned NIWA in 2013 to undertake a numerical modelling study to investigate the impacts on wave conditions in the South Taranaki Bight that may result from modifications to the seabed as a result of mining operations.

Gorman (2013) sets out the findings of this study, and concluded that changes in nearshore wave parameters associated with seabed pits and mounds formed during mining operations as presently proposed are expected to be minor in comparison with the natural level of variability in those values. Corresponding effects from the presence of a large moored vessel during mining operations are expected to be comparable to, or smaller than, the effects of the pits and mounds.

1.29.1 EPA Review Findings

The EPA commissioned SKM to undertake a review of Gorman (2013). The review concurred with the assessment in Gorman (2013) that the impacts of iron sand recovery activities on bathymetry, waves and erosion will be minimal. Predicted changes arising from the project are generally insignificant in comparison with the magnitude of natural variability in factors influencing coastal and oceanographic processes (such as wind and waves).

1.29.2 Joint Expert Conferencing Results

On 18 March 2014, a joint conference was held among experts on coastal stability. Experts agreed that the hydrodynamic and wave models (Gorman 2013 and Hadfield 2013) used to generate inputs to the assessment of potential effects of the proposed activities on physical drivers and shoreline processes (Hume et al. 2013) were consistent with international practice and appropriate for the purpose for the purpose of assessing potential effects of the proposed activities on shoreline processes.

Another joint conference among experts on wave and surfing effects was held on 20 March 2014. Experts agreed that the modelling methods used, the spatial resolutions selected, and the choice of outputs reported from those simulations, were appropriate for the study.

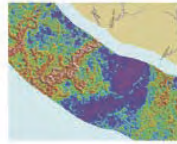
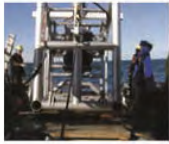

1.30 TTR Report: Potential Effects of Trans-Tasman Resources Mining Operations on Surfing Breaks in the Southern Taranaki Bight (eCoast Ltd 2013)

TTR commissioned eCoast Marine Consulting and Research to investigate the impacts of the project on surfing breaks in the Southern Taranaki Bight.

eCoast (2013) found that the principal effects on surf breaks arise from changes in the wave climate. The changes in wave directions mostly follow the changes in wave heights. Given the location over 20km offshore of the closest breaks, effects of the project are likely to be insignificant. Due to the process of refraction over this distance, wave crests will likely be realigned to the seabed contours offshore of the breaks to a similar direction as they would without the presence of the seabed modifications.

1.30.1 EPA Review Findings

The EPA Review of TTR's Technical Reports on the Physical Environment (SKM December 2013) concluded that eCoast (2013) was a valid assessment representing best available information.

1.30.2 Joint Expert Conferencing Results

A joint conference among experts on wave and surfing effects was held on 20 March 2014. Experts agreed that the results reported in the evidence of Dr Shaw Mead, indicating only minor effects from mining activity on the quality of surfing and surf breaks in Taranaki, were soundly based.



TTRL OFFSHORE IRON SANDS PROJECT

**SCIENCE PROGRAMME SUMMARY
REPORT**

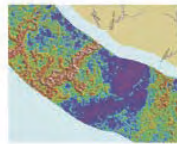
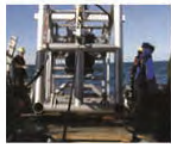

1. INTRODUCTION	3
2. PEER REVIEWS	5
<i>HR Wallingford Peer Review</i>	<i>5</i>
<i>Professor Cahoon's Peer Review</i>	<i>6</i>
3. TESTING REGIME.....	7
3.1 SEDIMENT SPECIFIC GRAVITY	7
3.2 SEDIMENT PARTICLE SIZE DISTRIBUTION.....	8
3.3 VISUAL SETTLING TESTS	8
3.4 TURBIDITY TESTS	9
3.5 SETTLING VELOCITY AND RESUSPENSION TESTS.....	9
4. 2015 MODELLING.....	9
4.1 NEAR FIELD MODEL	9
<i>General Description of the Near Field Process</i>	<i>10</i>
<i>Near Field Modelling Strategy.....</i>	<i>11</i>
<i>Near Field Modelling Conclusions</i>	<i>11</i>
4.2 SEDIMENT TRANSPORT MODEL	11
<i>Sediment model setup.....</i>	<i>12</i>
<i>Sediment recovery-derived sediments</i>	<i>13</i>
<i>Sediment model results.....</i>	<i>13</i>
<i>(Comparisons with previous modelling work)</i>	<i>13</i>
4.3 OPTICAL MODEL.....	18
<i>Optical Model Results</i>	<i>19</i>
5. ADDITIONAL REPORTS AND SURVEYS	19
5.1 ZOOPLANKTON COMMUNITIES AND SURFACE WATER QUALITY IN THE SOUTH TARANAKI BIGHT FEBRUARY 2015	19
5.2 ASSESSMENT OF THE SCALE OF MARINE ECOLOGICAL EFFECTS OF SEABED SEDIMENT RECOVERY IN THE SOUTH TARANAKI BIGHT 20	
<i>Assessment of Impact</i>	<i>20</i>
<i>Commercial and recreational fish species.....</i>	<i>21</i>
<i>Kaimoana species.....</i>	<i>22</i>
<i>Marine Mammals.....</i>	<i>23</i>
5.3 EFFECTS ON PRIMARY PRODUCTION OF PROPOSED IRON SAND SEDIMENT RECOVERY IN THE SOUTH TARANAKI BIGHT REGION	
24	
6. OVERALL SUMMARY	27
7. REFERENCES.....	28
8. APPENDIX 1: SUPPLEMENTARY SCIENCE LAYOUT	29

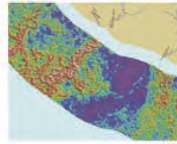
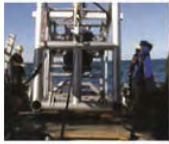

1. INTRODUCTION

Trans-Tasman Resources Limited (TTR) will, in 2016, lodge a marine consent application with the Environmental Protection Authority (EPA) under the Exclusive Economic Zone and Continental Shelf (Environmental Effects) Act 2012 (EEZ Act) for the recovery of iron sand from the South Taranaki Bight. This new application follows a previous application by TTR in 2013/2014, which was declined by a Decision-Making Committee (DMC) appointed by the EPA. The DMC identified concerns about the scale of the predicted effects on the environment, particularly regarding the extent and density of the sediment plume, the effects on primary productivity and the scale of impacts on existing interests specifically iwi and commercial fishing interests (EPA, 2014), which it now transpires were based on a number of very conservative assumptions.

In light of the above, TTR has undertaken an extensive programme to supplement and update its modelling and assessment on the extent and density of the plume that will be generated during the recovery of iron sand. The purpose of the programme undertaken by TTR has been to provide additional, refined technical information regarding the predicted extent and density of the plume.

To undertake this programme of work TTR has augmented NIWA's expertise by retaining world-leading experts in sediment modelling, optics and primary production from New Zealand, the United States of America and United Kingdom.

Before embarking on the specification of any supplemental work, TTR set two primary objectives for its supplementary science programme namely that it would first have to address the specific concerns raised by the EPA's DMC and secondly that it would inform the development of an agreed set of conditions and any associated management plans.

In defining the scope of the supplementary programme it was crucial to TTR that the integrity of its completed science assessment, which had been subject to robust verification and review by all participants in the application process, was retained and that any further work was not only complementary but added value by providing more definition and accuracy.

In this respect TTR worked closely with its original science providers, to identify acceptable, recognised experts in each of the concerned areas and the original science providers also helped develop the scope of the supplementary science program.

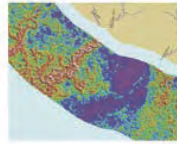
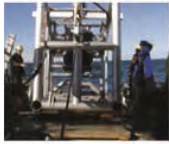

The additional technical information consisted of:

- A peer review of the methodology underpinning the modelling and assessment effort, as well as an evaluation of the basis for the assumptions and inputs into the plume model, optical model, and the assessment of effects on primary productivity;
- A sensitivity analysis that addressed specific variables and scenarios that could ultimately affect the impact that the sediment recovery operation would have on primary productivity;
- Further laboratory testing programs of:
 - Sediment settling rates;
 - Sediment re-suspension; and
 - Sediment aggregating mechanisms;
- Modelling and supporting studies in relation to the following:
 - Modelling of both the extent and density of the sediment plume;
 - Optical assessment of the effects of the sediment plume on primary production;
 - Detailed assessment of the effects on primary production; and
 - Source terms assessment;
- Zooplankton and surface water quality surveys in the South Taranaki Bight in February 2015; and
- The preparation of an assessment that addresses the spatial and temporal impact of iron sand recovery on zooplankton, seabirds, marine mammals, and fish species occurring in the South Taranaki Bight.

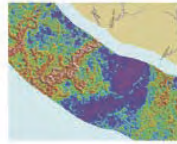
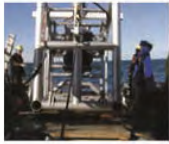

2. PEER REVIEWS

TTR has sought expert peer review advice on the project as follows:

- Specialist consultants, HR Wallingford (“HRW”), from the UK were commissioned to review all aspects of the sediment plume modelling previously undertaken;
- Professor Cahoon, from the University of North Carolina Wilmington, was retained by TTR to review all previous assessments of the optical effects of the proposal and the assessment of effects on primary productivity; and
- Dr Mark James and Prof Ian Hawes, who provided oversight and expert input to the additional science programme.

HR Wallingford Peer Review

HRW’s review addressed the following aspects in this order:

- The source terms for the sediment transport model;
- The near bed processes associated with the release of sediment;
- The integrity of the flow model used to drive the sediment transport modelling; and
- Sediment properties and associated assumptions used within the sediment transport modelling.

HRW firstly reviewed the origin and extent of the assumptions as to how much of the re-deposited material is available in suspension for introduction as a source for the NIWA sediment transport model. The basis for these assumptions was the MTI near field modelling. A detailed review of near field processes and scenarios modelled led HRW to conclude that the previous MTI “near-field” assessment over-estimated the amounts of fine material available for being dispersed within the NIWA sediment transport model. HRW recommended further assessment of near field source terms to better represent the amount and nature of material available for dispersion.

With regards to the actual NIWA flow model used to drive the sediment transport prediction, HRW concluded that it was appropriate and fit for purpose.

The HRW review also noted that the NIWA sediment transport model assumed that the material discharged into the environment would remain in its particulate (un-flocculated) form. The review of the sediment properties and associated assumptions led HRW to conclude that the assumed settling velocities for the fine material as used in the NIWA modelling were too low and did not adequately represent the processes of flocculation that would occur. The applied assumptions resulted in an over-estimate of the turbidity in the water column and hence an overestimate of impact on light reduction.

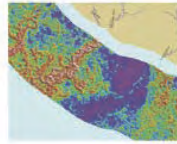
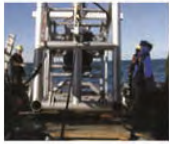

Further laboratory scale tests were recommended to determine sediment particle settling rates, the effect of flocculation, and the required shear stress needed to re-suspend settled particles.

Professor Cahoon's Peer Review

Professor Cahoon noted that the conservative nature of the assessments was generally appropriate, but identified areas where this approach, in his opinion, was applied excessively (Cahoon, 2014a).

While Professor Cahoon identified the disturbance of sediment as the key environmental impact of the proposal, he regarded NIWA's assumption that the iron sand recovery process will essentially destroy all biota in the sediment as excessive. While the assumption is likely true for macrobenthos and soft bodied organisms, his experience showed that microbiota would survive the recovery process rather well (Cahoon et al. 2012). He also expects bacteria to survive the process, allowing them to colonise any open surface areas on sediment particles within the created plume. Bacterial populations provide the "mucus" that contributes to making fine sediment particles cohesive as part of their adaptation to life at the sediment-water interface thus reducing their own vulnerability to suspension feeders, and allowing them to benefit from the steady advection of new resources that flow past them.

Professor Cahoon was of the opinion that the iron sand recovery process would temporarily reduce the populations of macrobenthic organisms, thus stimulating benthic microfloral production in the near-term (days to weeks following iron sand recovery), and in doing so providing a locally charged flocculation mechanism that would aid the settlement of sediments in the water column.

Professor Cahoon reinforced the point made by HRW that NIWA's decision to exclude the mechanism of flocculation from the initial modelling was unrealistically conservative. Floccs (aggregated particles) form naturally in the natural environment, especially when microfloral mucopolysaccharides are present.

Professor Cahoon stated that apart from enhancing settling rates, the formed floccs become food for suspension feeders and is confident, given the natural dynamic nature of the seabed in the South Taranaki Bight that these organisms will be extremely well adapted to consuming formed floccs and nepheloid material (i.e. material just above the seabed that's intermingled with significant suspended sediment). Professor Cahoon contends that any organism living in the soft-sediment environment of the South Taranaki Bight being subjected to occasional sediment suspension events will have similar capabilities.

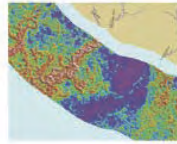
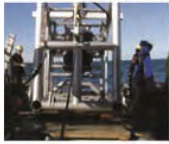

Professor Cahoon advised that it is not appropriate to assume that a particular population of macrobenthos, such as the tube dwelling worms, are supported by the production occurring in the water column directly above them. Professor Cahoon's own studies have shown that advective (horizontal) transport supplies 10 to 100 times more organic material to a population of benthic suspension feeders than the biomass immediately above them. This reinforces the view that the disturbance of sediment within the production area will have relatively little effect on food supply for macrobenthos within the South Taranaki Bight, because the food supply is a factor of the movement of water and materials at scales of km per hour.

With regards to the estimates of impacts on primary production, Professor Cahoon stated that benthic microalgae (the photosynthetic component of the benthic microflora) would readily adapt to fluctuating light regimes and pointed to the fact that he himself has published several papers addressing this specific ability of benthic microalgae to adapt to very low light conditions (McGee et al. 2008; Cahoon et al. 1992). Professor Cahoon made the point that given the South Taranaki Bight produces regular natural suspension events, benthic microalgae would be well adapted to changes in light flux, thus minimising the impacts of any transitory sediment extraction event on their primary production.

3. TESTING REGIME

HRW undertook a series of laboratory tests to investigate the behavior of the sediments to be discharged under both saline and fresh water conditions. Tests were carried out to look at settling velocity, flocculation and critical shear stress for deposition and erosion.

The following laboratory tests were carried out by HRW on supplied sediments:

- Sediment specific gravity;
- Sediment particle size distribution;
- Settling tests;
- Turbidity tests;
- Settling velocity measurements ;
- Flocculation measurements; and
- Critical shear stress for deposition and erosion.

3.1 Sediment Specific Gravity

A representative sample of TTR supplied sediments from which the ore had been removed was used to determine the specific gravity of the typical "post-grind" fraction that would be deposited on the sea-floor. The results are provided in table below.

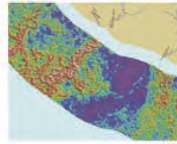
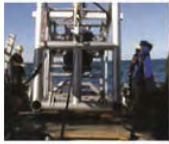

Sediment Sample	Description	Specific Gravity
1	TTR. X451 . 2 kg. Post-Grind Sediments. Composite Sample	3.11
2	Bulk 5030. Pre Grind. Ultra Fines	2.66
3	Bulk 501. L2. P1. IBC. Tails. 11.7 kg	2.82

3.2 Sediment Particle Size Distribution

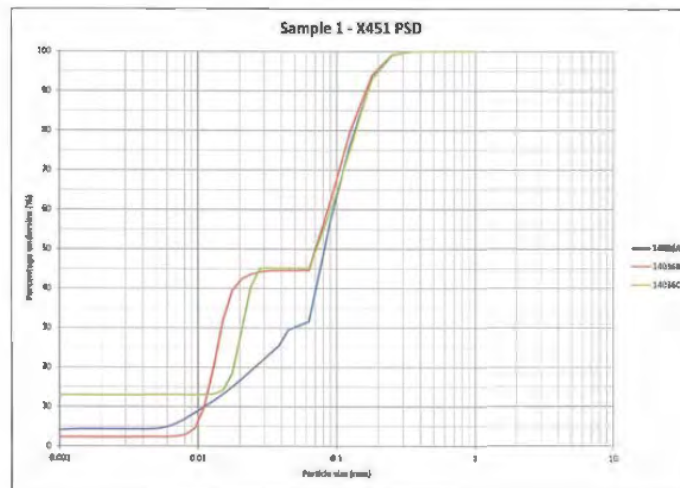
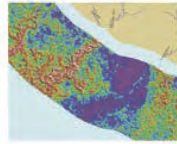
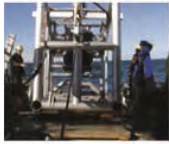

Figure 1: Post-Grind Sediments. Composite Sample

3.3 Visual Settling Tests

Visual settling tests were carried out on each of the three sediment types. Photographic records were made of 100mg/l and 1000mg/l sediment suspensions settling in 1 litre of both deionised and salt water over a three hour period.

The results of the visual settling tests demonstrated that all three material types flocculated when introduced into both salt water and deionised water. Importantly the visual settling tests demonstrated that, for all three samples, even after 3 hours there was still a proportion of very fine material in suspension.



3.4 Turbidity Tests

Following the suspension mass tests further test were undertaken to monitor the turbidity of the water as 8g samples of Sediment 3 (<0.038mm) settled through 8 litres of both salt water and deionised water over a period of 3 hours.

3.5 Settling Velocity and Resuspension Tests

The results of the tests undertaken by HRW suggest that the mass of fine sediment that will be disperse within the middle and upper parts of the water column upon release by sediment recovery will reduce by a factor of 3-5 (compared to the revised NIWA prediction) as the majority of released fine sediment will settle to the bed or near-bed waters because of higher rates of settling.

It was also found that the critical shear stress for resuspension of freshly deposited material was likely to be in the range of 0.2 to 0.3Pa rather than the 0.1Pa assumed by NIWA, meaning that resuspension of settled sediments was much lower than previously assumed.

4. 2015 MODELLING

4.1 Near Field Model

TTR's initial "near field" model was prepared by MTI in 2013 to provide an indication of the quantity of sediment that after release would help define the extent and density of resultant plume. The MTI model simulated the near-field mixing arising from sediment discharge via a pipe from 4m (and 9m) above the bed (MTI, 2013a, 2013b).

The peer review by HRW noted that the limitations of this initial model (i.e. not accounting for the initial radial collapse of the density current formed by the plume impinging onto the bed of the pit, considering only the coarse sediment discharge and the near-field mixing of sub 38 micron material) contributed to a significant, unrealistic overstating of the quantity of sediment available for further dispersion.

In addition, the peer review by HRW also found that the assumption made in the sediment transport model, that all of the fine sediment fractions were available for dispersion into the far-field, was overly conservative as there was a high likelihood that a portion of the fine sediment would be trapped in the immediate vicinity of the initial discharge. Based on this finding, TTR commissioned HRW to repeat the near field model in order to investigate the proportion of fine sediment that would be trapped in the pit - thereby allowing TTR to better define the proportion of fine sediment that would be available to be dispersed into the far-field, informing the final sediment transport model.

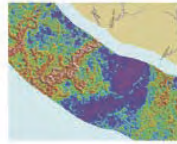
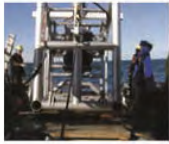

General Description of the Near Field Process

The figure below illustrates the general setup of the sediment recovery vessel and crawler. The crawler will dredge a lane approximately 25m in width at an average of 5m in depth, moving at an average speed of around 1cm/s. The Sediment recovery Support Vessel will be winched along the extraction path maintaining its position and orientation above the crawler.

At the leading edge of the new extraction block the crawler will be removing sediment while the vessel deposition pipe will be placing sediment back into an already de-ored pit, 300m south west of the crawler with the entire operation moving steadily in a northeast direction.

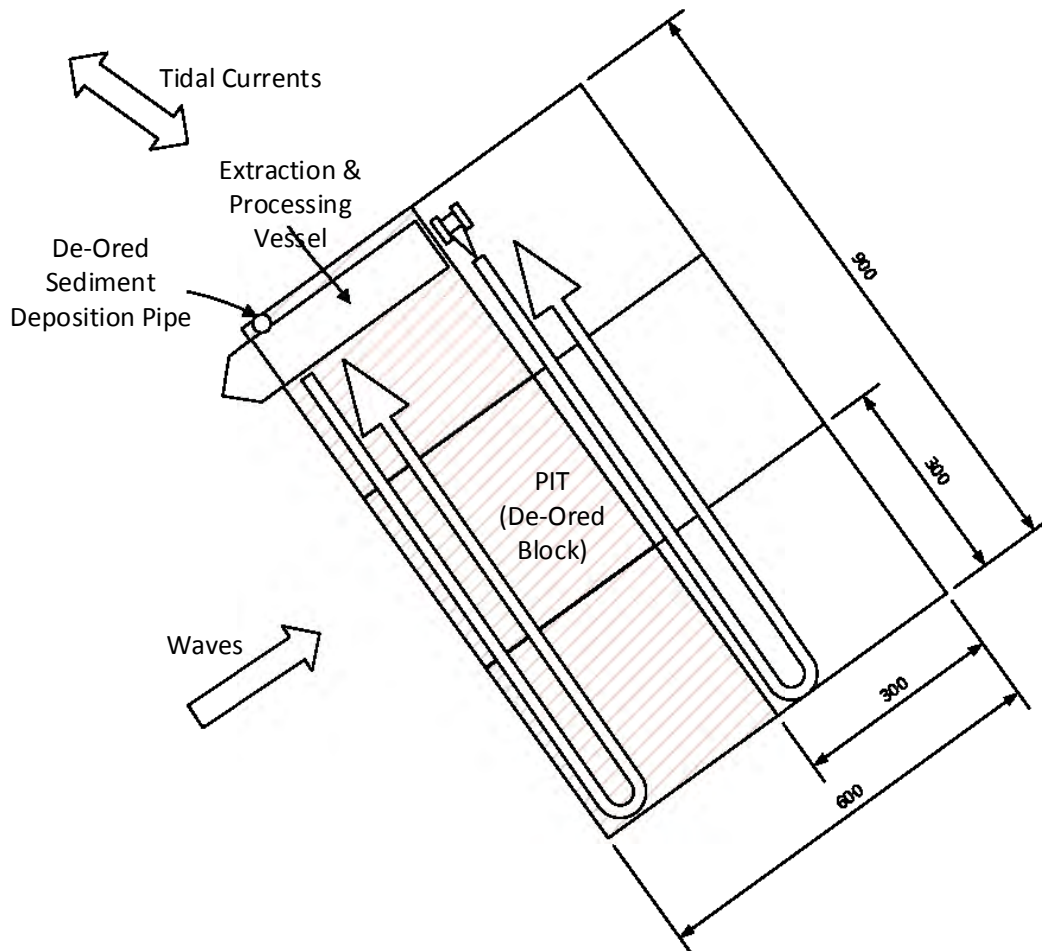
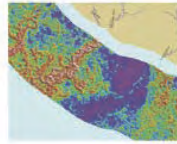
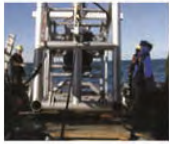

Fig 2: General Sediment Recovery Setup



During the iron sand recovery operations the residual sediment will be introduced into the water body via a single deposition pipe. The introduction of this combined sediment into the water column will result in a dynamic slurry plume that will be denser than the surrounding water, enabling a rapid descent towards the seabed. The dense plume will then collapse onto the seabed, slowly expanding and mixing with the overlying waters, this dynamic mixing will also be characterised by a slowing particle settling rate.

The sediment discharge will spread over the vast majority of the pit with the sandy, coarse material settling out closest to the point of discharge, while the finer sediment is expected to spread farthest. The settling of these slower settling fine fractions to the seabed within the pit will be limited by the action of currents which will tend to move sediment which has not settled within a certain time frame out of the pit.

Near Field Modelling Strategy

The HRW near field modelling utilised two different models to identify the behaviour of sediments released into the pit. A 3D model was used to show how the sediment deposition, the spatial arrangement of the placement in the pit, the formation of the density current, tidal currents and waves would interact with suspensions of the slowest settling fine sediment fractions.

A further model was then used to consider the interaction of different sediment fractions. This model used a simplified, homogeneous view of the behaviour of sediment in pit.

Near Field Modelling Conclusions

The near field modelling conducted by HRW established that all the fine sediment fraction settling at 10mm/s, 25% of the 0.1mm/s fraction, and 5% of the 0.01mm/s fraction would be entrapped in the placed material during the initial deposition process.

The remainder of the fine sediment will flow out of the pit and mix both horizontally and vertically. Because of its low settling velocity, this unconstrained sediment would tend to form a uniform concentration throughout the water column. This fine slow settling sediment would still be expected to form flocs with the background natural sediment and with fine material released by subsequent mining activity, which contains elements of biological material (e.g. extra cellular polymers), and would eventually aggregate to form larger flocs progressively settling out. The assumption in the NIWA sediment transport model of a constant settling velocity for the slowest settling material (0.01mm/s) is thus conservative and unrealistic.

4.2 Sediment Transport Model

Following the detailed review and a subsequent test program by HRW, TTR commissioned NIWA to produce an updated sediment transport model that allowed for more accurate modelling of the plume in relation to the following:

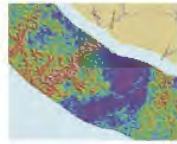

- Flocculation: The original plume model neglected flocculation, a process in which fine sediment particles combine into fast-sinking aggregates;
- Sediment Settling Rates: The extent to which the fine suspended sediment would settle to the bottom and be trapped in the matrix of discharged sand is predicted to occur to a greater extent than assumed previously; and
- Sediment Re-Suspension: The testing by HRW found that the shear stress required for re-suspension of freshly deposited material was in the range 0.2–0.3Pa rather than the 0.1Pa (minimum value), as originally assumed by NIWA.

Sediment model setup

Sediment calculations were carried out on the two inner domains each nested within a larger-scale Greater Cook Strait model.

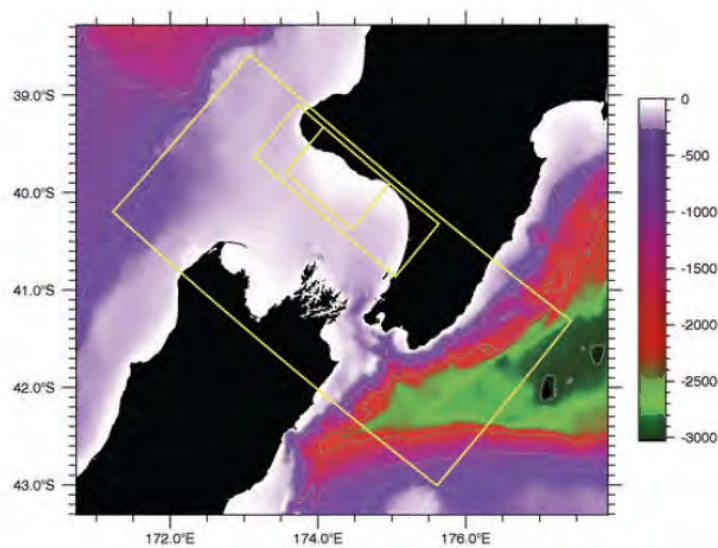

Figure 3: Sediment Model Setup

Background sediments

The base simulation represents background sediment processes using 7 sediment classes:

- The river-derived sediments that are injected by the rivers. There are two classes: coarse silt (16–63 μ m) and a fine silt/clay (< 16 μ m); and
- The seabed-derived sediments comprise the seabed at the beginning of the simulation. They range from coarse sand (500–1000 μ m) to fine silt (4–16 μ m).

There were two reasons for including the background sediments:

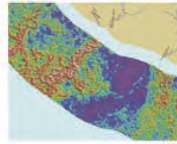

- Primarily, to acknowledge the interaction between the sediment recovery-derived sediment plumes and the seabed; and
- Secondly, to produce estimates of background suspended sediment concentrations that can be compared with predictions of sediment concentrations resulting from the iron sand recovery operation.

Sediment recovery-derived sediments

Two main sediment streams from the iron sand recovery are considered in the sediment plume model: the hydro-cyclone overflow discharge and the de-ored sand discharge.

The de-ored sand discharge involves de-watered, de-ored sand being released from a pipe with a view to depositing it as compactly as possible, usually into a pit that has been excavated earlier. The de-ored sand is predominantly fine-medium sand (125–500µm) with some finer material. Both discharges are no more than 4m or so above the bottom of the seabed, and in the current proposal, are released close to each other - with a view to maximising the trapping of fine sediment in the pit with the coarser sands.

Sediment model results

(Comparisons with previous modelling work)

The effect of the increased definition in the elements listed above on the predicted plume extent and density can be demonstrated by comparing the median near surface results for sediments released from the most inshore and offshore mining locations in the modelling done in 2014 to that done in 2015. Results are presented for the whole domain of the sediment model.

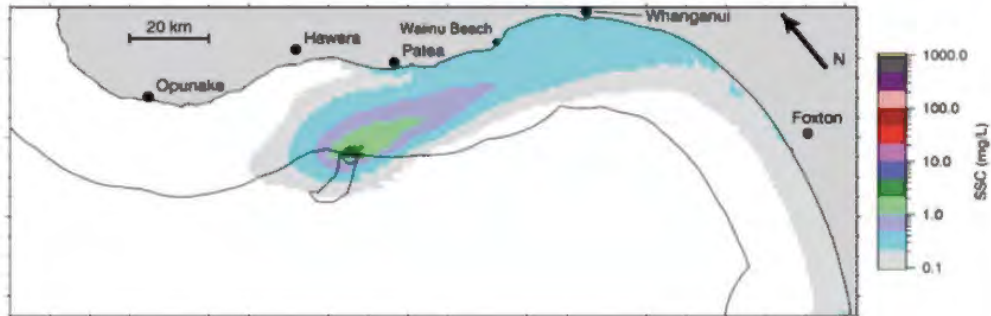
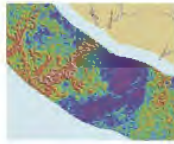

Figure 4: Inshore Sediment Release Median 2014

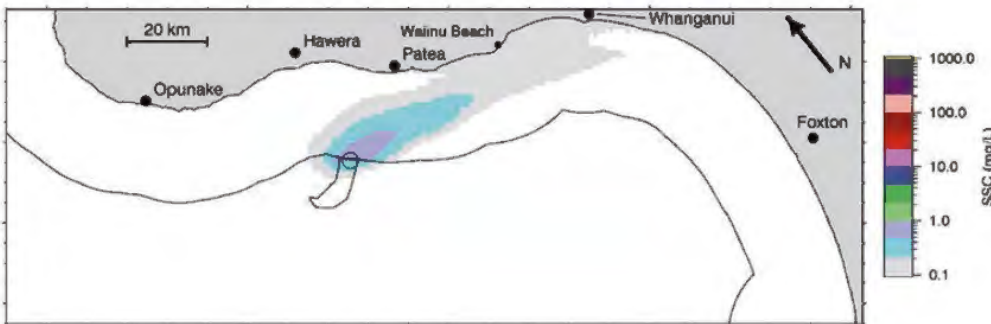

Figure 5: Inshore Sediment Release Median 2015

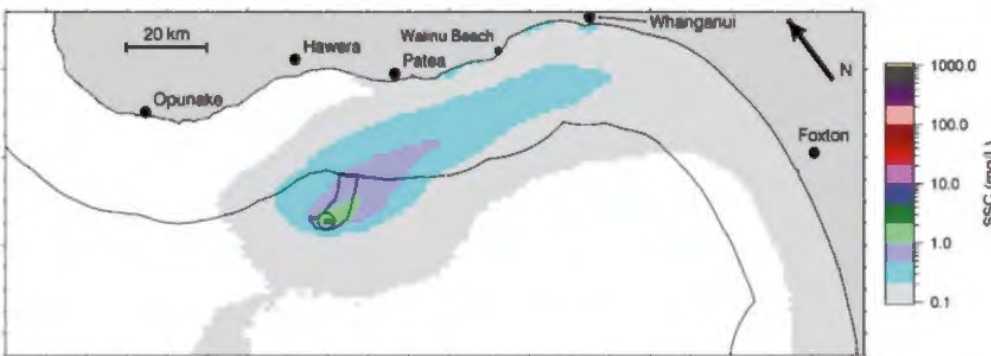

Figure 6: Offshore Sediment Release Median 2014

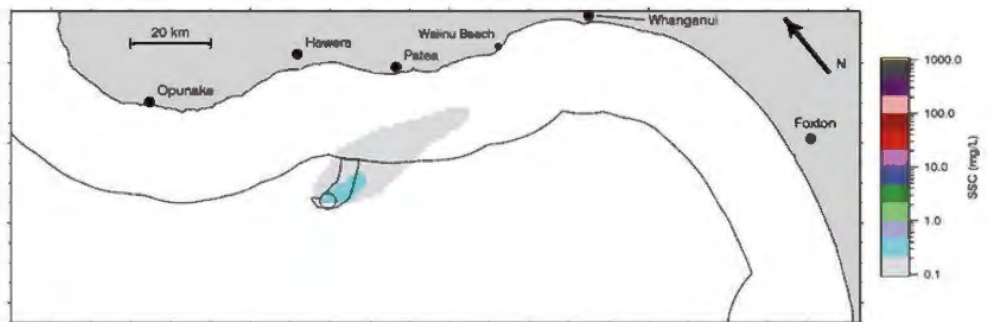
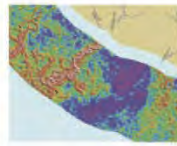

Figure 7: Offshore Sediment Release Median 2015



Comparisons with background

The effect of the plume created by the iron sand recovery derived sediment compared to background sediments can be demonstrated by comparing the near surface results for background with the background plus sediments released in the iron sand recovery operation.

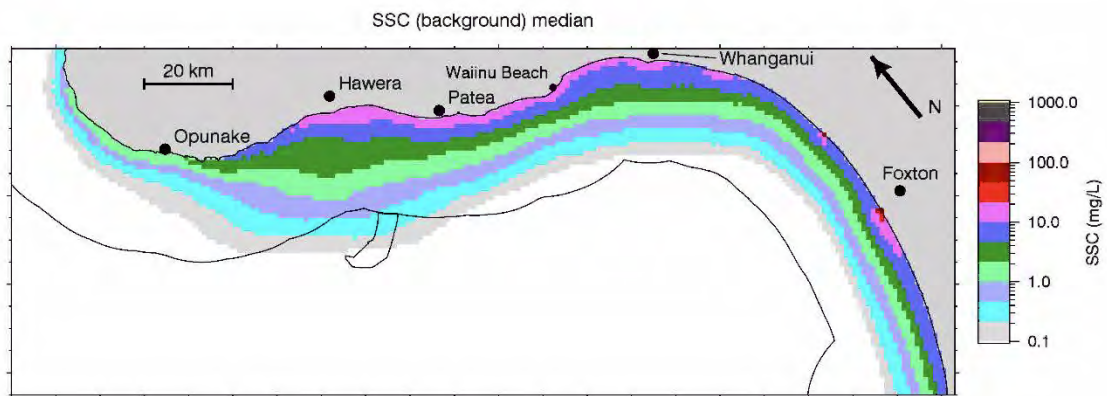

Figure 8: Background Suspended Sediment Concentration Median 2015

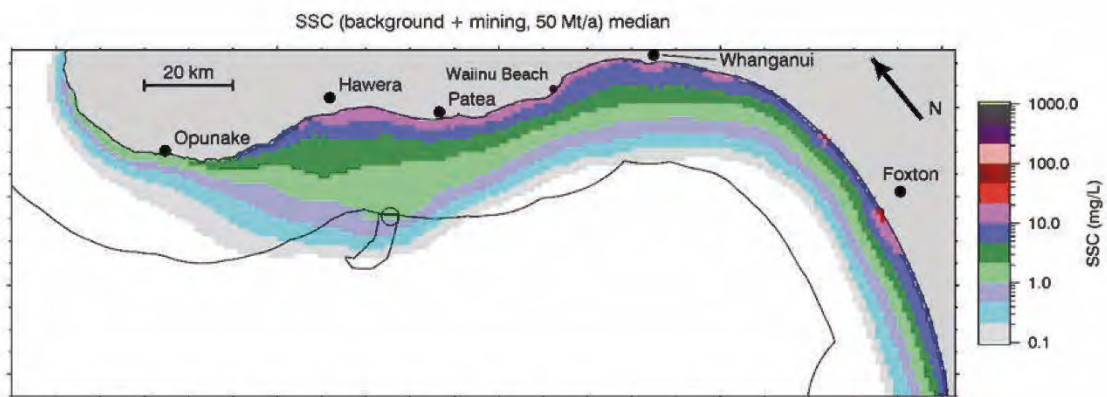
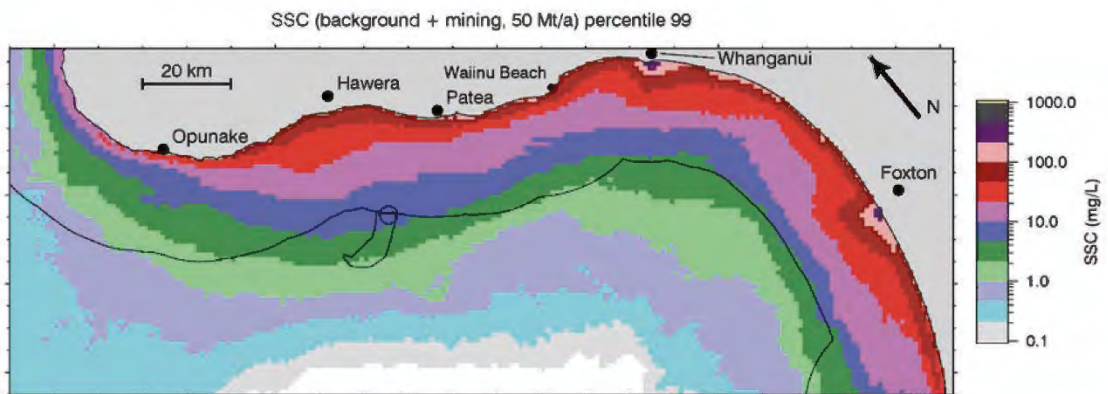
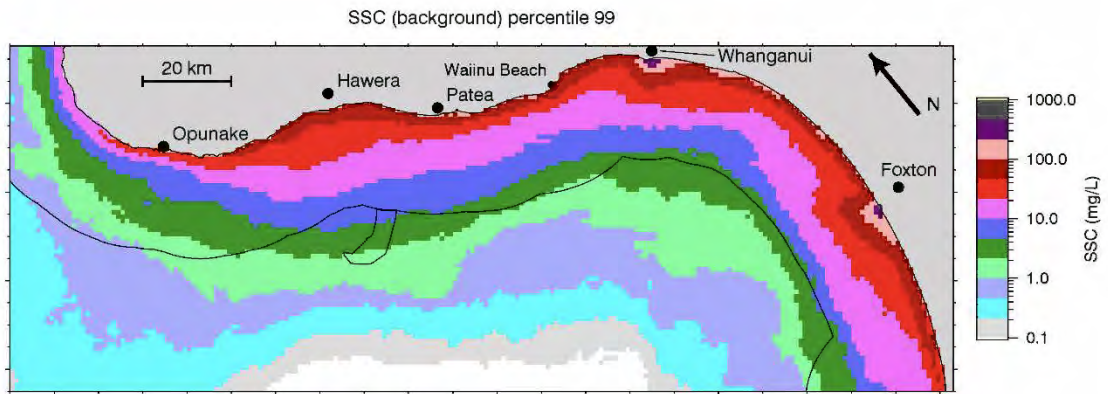
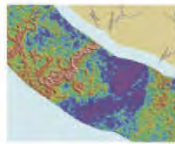
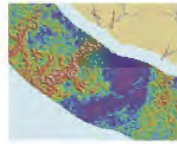

Figure 9: Background + Mining Suspended Sediment Concentration Median 2015



Figures 10 & 11: 99th Percentile Near-Surface Concentration of Suspended Sediment from Sediment Recovery (50 Mt/a) at the Nearshore Location. Top: Background SSC; Bottom: Background Plus Mining-Derived SSC.



Deposition

The figures in this section show rates of sediment deposition associated with the suspended sediment source at the most inshore location (i.e. just outside the 12 nautical mile limit). The deposition footprint of iron sand recovery-derived sediment is widespread but at very low values of 0.01–0.05mm, (i.e. tenth of a thickness of a human hair). The deposition of iron sand recovery derived sediment could therefore only be able to be distinguished from the background within a few kilometres of the source.

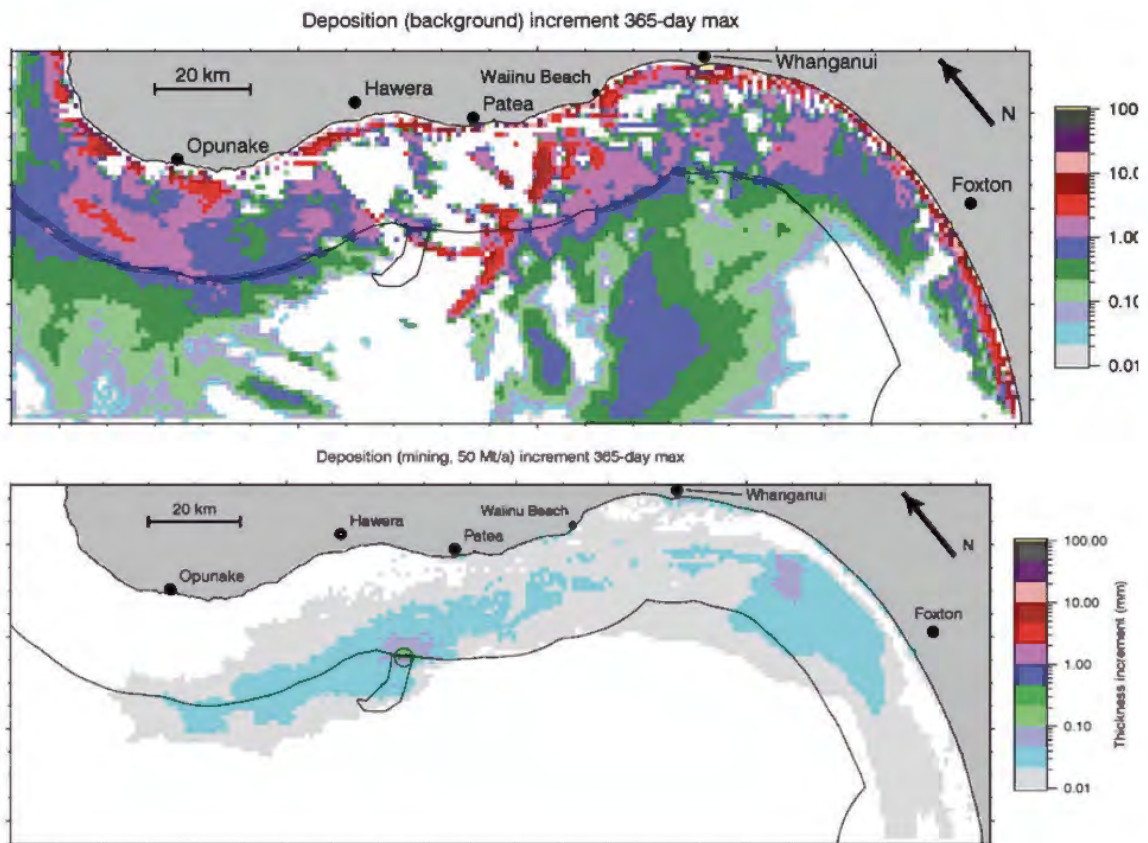

Figures 12 & 13: Max Sediment Deposition 365 day

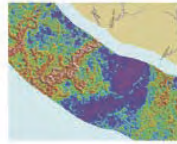
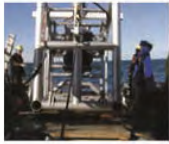

4.3 Optical Model

The optical model takes inputs of the concentration of sediment as predicted by the updated hydrodynamic model of Hadfield & Macdonald (2015). The sediment recovery-derived sediment is modelled in three categories of settlement rates (0.01, 0.1, and 1 mm/s), to take account of the effects of flocculation (Hadfield & Macdonald 2015). The method of assessment is contained in Figure 16 below.

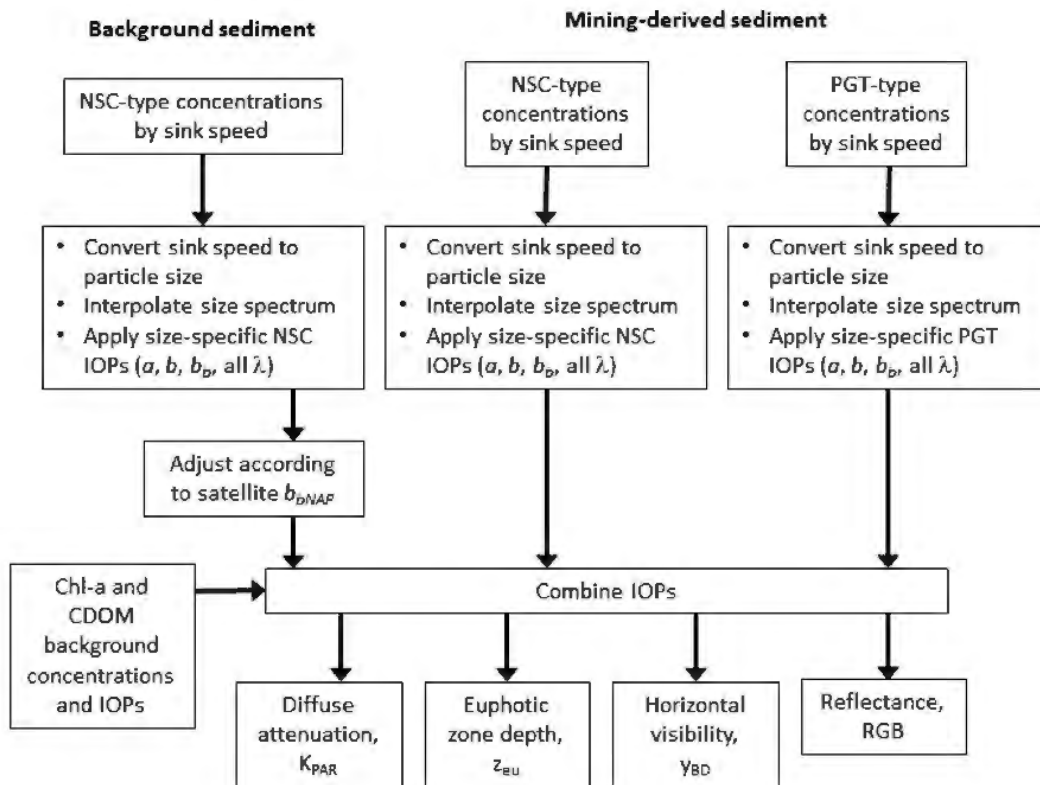
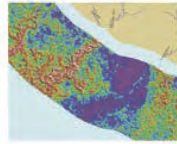
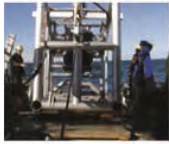

Figure 14: Optical Model

Optical effects were predicted based on iron sand recovery at two different representative locations (Site A, which is located at the inner limit of the proposed operations, close to the 12 nautical mile limit and Site B, which is located at the outer extent of the proposed operation)



Optical Model Results

The optical model predicted the following:

- The optical effects of mining are likely to cease very quickly after mining ceases;
- There is substantial natural variability in optical properties in the modelled area with greater turbidity at the coast;
- The optical effects of the plume decrease away from the iron sand recovery operations;
- The optical effects of the plume will be greater in the offshore area than in the nearshore area with effects being minimal close to the coast (i.e. within approximately 5km of the coast);
- Average light in the water column averaged over the domain of the sediment model (an area of 13,000km²) is predicted to be reduced by only a small amount - approximately 1.9% based on ore recovery at Site A and 1.6% based on ore recovery at Site B; and
- The total amount of light received by the seabed in the domain of the sediment model is predicted to reduce by 23% (Site A) and 16% (Site B), and this reduction will occur primarily east of the proposed iron sand recovery operation.

5. Additional Reports and Surveys

5.1 Zooplankton Communities and Surface Water Quality in the South Taranaki Bight February 2015

Zooplankton communities in the South Taranaki Bight were well assessed in the 1970s and 1980s, with 90 stations sampled over a period of 13 years. This resulted in the DMC on the previous marine consent application questioning the relevance of the older data to a modern assessment of iron sand recovery impacts. Moreover, most of the sampling stations (83%) were in depths > 50 m offshore of the sediment recovery stations, with just a few from the areas likely to be affected by sediment plumes from the proposed activities.

In light of the above, TTR contracted NIWA to sample zooplankton communities from the sea surface to the sea floor, and take and analyse surface water samples for components affecting water clarity, at 16-20 stations along the length and across the width of the area potentially affected by the sediment plume. Weather conditions allowed this sampling to take place in mid-February 2015.

The zooplankton community sampled in February 2015 is typical of the nearshore zooplankton communities found around the North Island. Its specific composition closely resembles Zooplankton Geographic Group III that occurred in the same area in the 1980s, thus verifying the relevance of the 1970s and 1980s data to a modern assessment of sediment recovery impacts.

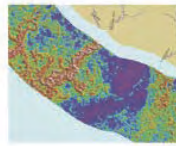

5.2 Assessment of the Scale of Marine Ecological Effects of Seabed Sediment Recovery in the South Taranaki Bight

TTR commissioned NIWA to provide an overview of the effects of the proposed iron sand recovery activities on key zooplankton, fish, seabird, kaimoana, and marine mammal species, taking into account the spatial and temporal scales relevant to different components of the ecosystem, particularly addressing matters of uncertainty relating to those effects. This assessment has utilised the latest sediment transport and optical modelling results (as summarised above).

Assessment of Impact

The effects or consequences of the proposed iron sand recovery activities were evaluated for each component of the ecosystem being considered and scored using a standardised set of “consequence descriptions”. These take into account the proportion of habitat relevant to the species or group in question affected by iron sand recovery activities, the severity of the impact on the population, community, or habitat, and the recovery period once the impact ceases.

The effects taken into account in this study were:

- clogging of respiratory surfaces and feeding structures of marine organisms;
- avoidance of the discharge area by mobile species; and
- reduced availability of prey due to either reduced underwater visibility or a reduction in prey numbers or biomass.

The review used ecologically consequential concentrations of suspended sediment of 2mg/l as a conservative minimum threshold for all pelagic species of fish and invertebrates, sea birds, and marine mammals, and 3mg/l as a conservative threshold for all demersal and benthic species of fish and invertebrates.

This review and assessment of the spatial and foraging ecology of the key fauna occurring in the South Taranaki Bight has identified that the environmental effects due to the proposed iron sand recovery operations for all zooplankton, seabird, and marine mammal species, and most fish species will be negligible.

This report summarises the detail findings with respect to fish and whales below. Detailed findings for each of the key fauna can be referenced in the full report.

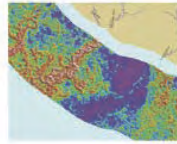
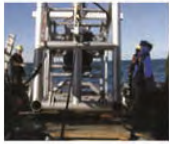

Commercial and Recreational Fish Species

Of the commercial and recreational fish species commonly occurring (% occurrence >50%) in the South Taranaki Bight (STB) all pelagic species and all but one of the demersal and benthic species will be negligibly affected by the proposed iron sand recovery operations. Because:

- iron sand recovery activities comprises less than 1% of their area of distribution in their Quota Management Area;
- individuals are relatively mobile, and occur either close inshore in areas already subject to high background levels of suspended sediment concentrations, or principally offshore of the area impacted by iron sand recovery; and
- NIWA concluded that any displacement of fish or decrease in prey abundance or availability due to the proposed iron sand recovery activities will have negligible effects on the state of their stocks.

The only exception is the eagle ray. Although the area potentially impacted by iron sand recovery activities comprises less than 1% of the area of distribution of eagle ray in Fisheries Management Area 8, about 8% of its core area of distribution (>50% occurrence) overlaps with the area of suspended sediment concentrations elevated above 3mg/l. Using this threshold a minor to moderate proportion of the stock could be affected by iron sand recovery activities through displacement of fish, or decrease in prey abundance or availability.

During summer and autumn eagle rays tend to concentrate inshore in water less than 10m deep where background suspended sediment concentrations may naturally reach over 100mg/l (Hadfield et al. 2015). This means that eagle rays may be tolerant to suspended sediment concentrations significantly higher than the threshold of 3mg/l used to assess the impact of suspended sediment concentrations elevated by the proposed iron sand recovery activities. As such the above assessment is an over-estimation of the effects on eagle rays.

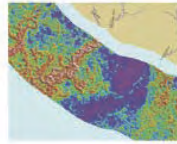

Kaimoana Species

The kaimoana species fished or gathered in the South Taranaki Bight were divided by NIWA into three groups on the basis of their ecology and where they were located. In the first group are five fish species occurring close inshore or penetrating reaches of the river systems in the region, and a large number of invertebrate species fished or gathered from intertidal and shallow sub-tidal parts of rocky reefs or muddy or sandy shores where the waters are commonly naturally turbid. The fish include kanae (grey mullet), patiki mohoa (black flounder), tuna heke (long finned eel), tuna roa (short finned eel), and paraki/ngaiore (common smelt). The invertebrates include koeke (common shrimp), kaunga (hermit crab), papaka parupatu (mud crab), papaka (paddle crab), waikaka (mudsnail), pipi, purimu (surfclams), tuangi (cockle), tuatua, kotore or humenga (sea anemone), kina (sea urchin), patangatana (starfish), karaura (rock oyster), kutae/kuku (green lipped and blue mussel), pupu (cats eye), rori (sea-snail), paua and hihiwa (black- and yellow-foot paua), kaeo (sea tulip), and waharoa (horse mussel). Given that their main area of distribution in the STB is close inshore in naturally turbid water, or in freshwater rivers, they will not be affected by the iron sand recovery activities and any displacement of fish or decrease in prey abundance or availability due to iron sand recovery will, according to NIWA, have no or negligible effects on the state of their stocks.

The second group includes two species, hapuka (groper), and para (frostfish), with a broad distribution in the STB but with their centre of distribution in deeper offshore waters, and seven other species including kuakua (scallop), and rore/rori (sea cucumber), moki (blue moki), patiki rore (New Zealand sole), patiki totara (yellowbelly flounder), patiki (sand flounder), and reperepe (elephantfish) occurring mainly in depths less than 50m. Given that the area of SSC concentrations elevated over background levels by the proposed iron sand recovery operations comprises less than 1% of the area of distribution of these species in Fisheries Management Area 8, any displacement of individuals or decrease in prey abundance or availability due to the proposed iron sand recovery activities has been assessed by NIWA to have negligible effects on the state of their stocks.

In the third group is rocky reef, demersal or benthic species occurring mainly close inshore but with their distributions extending across the inner part of the shelf to depths of 50m wherever suitable habitat occurs. This group includes marari (butterfish), koiro (conger eel), koura (rock lobster or crayfish), and wheke (octopus). Although their populations close inshore will be largely unaffected by iron sand recovery, it is possible that individuals occurring at or near the recovery site or areas affected by the near seafloor sediment plume, could be displaced or experience a decrease in food abundance or availability. However, for each species the impact on their overall population will be negligible.

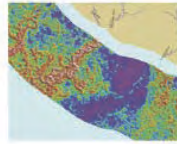
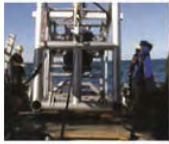

Marine Mammals

Blue Whales

Blue whales have been predominately sighted in the western entrance to the South Taranaki Bight between the 50 and 150m bathymetric contours. A dedicated aerial cetacean survey over two years failed to detect any blue whales in the vicinity of the proposed iron sand recovery areas, which the Joint Statement of Experts in the Field of Effects on Marine Mammals including Noise concluded may represent the edge of the blue whale feeding grounds in the South Taranaki Bight as part of the consideration of TTR's first marine consent application.

The potential feeding area of blue whales in the South Taranaki Bight is approximately 29,930km² if areas shallower than 25m are excluded. NIWA has determined that given the areas where suspended sediment concentrations are elevated above 2mg/l due to the proposed iron sand recovery represents only 0.2% of this potential feeding area, and lies on the margins of blue whale feeding grounds. Therefore the assessment, which is based on the best available information, shows that any displacement of blue whales or decrease in krill abundance or availability due to iron sand recovery will have negligible effects on blue whales while in the South Taranaki Bight.

Southern Right Whales

Given that southern right whales are unlikely to be feeding on locally available prey during the period they transit through the inshore waters of the South Taranaki Bight, and that modelling predicts that the majority of the South Taranaki Bight is unfavourable habitat for southern right whales during the winter calving, suckling and migration period, NIWA considered that the proposed sediment recovery activities will not affect this species.

Killer Whales

The majority of the South Taranaki Bight is regarded as only moderately favourable habitat for killer whales, with its prey species occurring over a wide area in the South Taranaki Bight.

The proposed iron sand recovery activities are assessed not to cause any measurable displacement, or decrease prey abundance or availability during the periods that killer whales visit the region.

Hector's Dolphin

The majority of the South Taranaki Bight is unfavourable habitat for Hector's dolphins - demonstrated by the near absence of sightings of Hector's dolphins in the region. The preference of Hector's dolphin for areas of low water clarity, and the likely negligible effects of iron sand recovery activities on stocks of prey species, means that sediment recovery is assessed not to have any effects on this species.

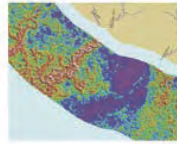
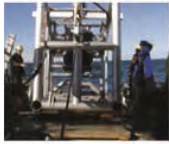

Common Dolphins

Common dolphins have a wide distribution and wide ranging movements around New Zealand. NIWA has concluded that any displacement of common dolphins, or decrease in prey abundance or availability due to proposed iron sand recovery will have negligible effects on the status of the common dolphin population in the South Taranaki Bight.

Pilot Whales

Pilot whales have a wide distribution and wide ranging movements around New Zealand. Any displacement, or decrease in prey abundance or availability due to sediment recovery activities will, according to NIWA, have negligible effects on the status of the pilot whale populations.

5.3 Effects on Primary Production of Proposed Iron Sand Sediment Recovery in the South Taranaki Bight Region

This assessment addresses the impact on primary productivity that would result from the release of sediment into the water column. The increased suspended sediment in the water column will affect the optical properties of the water, specifically its clarity and colour, which may, in turn, affect biota. The optical effects of iron sand recovery (as distinct from “mass effects”) include changes to light attenuation, which affects the amount of primary production (PP) by reducing light availability for algae in the water and on the seabed.

The optical models have been rerun and the results carefully reviewed by TTR’s local and offshore advisors. The key results of their new assessment are as follows:

- Light in the water column, integrated over the modelled area and averaged by year, is predicted to be reduced by 1.9% (iron sand recovery at Site A) and by 1.6% (iron sand recovery at Site B);
- Under “natural” conditions, about 28.6% of the seabed of the modelled area receives more than 0.04 mol photons m⁻²d⁻¹. This is an estimate of the approximate minimum light requirements for MPB to grow (Gattuso et al. 2006) (though it is possible that MPB can grow at lower light levels than this). The area is predicted to reduce to 27.1% overall (iron sand recovery at Site A) and to 27.3% overall (iron sand recovery at Site B);
- The total amount of light at the seabed over the whole modelled area averaged over a year is predicted to reduce by 23% (iron sand recovery at Site A) and by 15% (iron sand recovery at Site B); and
- Most of the reduction in sea bed light is predicted to occur in a band spreading east from the location of iron sand recovery.

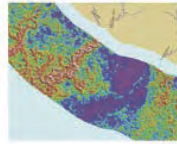
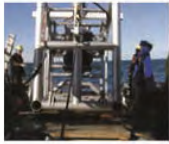

Based on the prediction of the optical model, estimates of likely reductions in primary production (“PP”) by phytoplankton in the water column and PP by macroalgae (seaweed) and microphytobenthos (MPB) on the seabed were made, using values taken from the international literature. Five changes are considered in the context of assessing the optical effects of iron sand recovery on the ecology of the SMD:

- Changes to PP in the water column by phytoplankton;
- Changes to PP by macroalgae;
- Changes to PP on the seabed by microphytobenthos;
- Changes to total PP (i.e., the sum of all sources of PP); and
- Changes to energy flow to the seabed ecosystem. Energy available to animals in/on the seabed comes from the combination of local (seabed) PP and the transfer (flux) of organic matter from the water column to the seabed.

In all cases it was not possible to predict changes to absolute production, rather estimates are based on proportional changes to the background condition.

The following issues are fundamental when estimating the possible changes in PP resulting from optical effects, and none of these is well known:

- The degree to which photo-saturation and photo-adaptation by phytoplankton and MPB will offset the effect of reductions in light on PP;
- The relative importance of MPB and phytoplankton for total PP in the SMD. PP by phytoplankton will dominate, but the contribution of PP from MPB is not well known; and
- The proportion of the total flux of organic carbon to the benthic ecosystem that is due to sedimenting water column carbon compared to advected or local benthic production by MPB.

Using optical modelling results and expert estimates for the above factors, TTR’s advisors predict that iron sand recovery will:

- Reduce water column PP averaged over the modelled area by 1.0% (iron sand recovery at Site A) and by 0.8% (iron sand recovery at Site B);
- Likely have small effects on macroalgal production. The distribution of macroalgae is poorly known for much of the modelled area, and effects are hard to predict quantitatively. However, known macroalgal habitats, including the Traps, are in areas where the impacts of the iron sand recovery operations are predicted to be small;
- Reduce benthic PP averaged over the modelled area by 19% (iron sand recovery at Site A) and 13% (iron sand recovery at Site B);

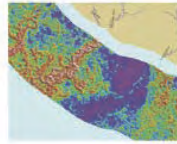
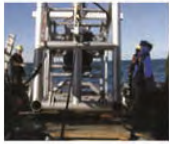

- Reduce total (i.e. water column plus seabed) PP averaged over the modelled area by 1.9% (range 1.6–2.2%) due to iron sand recovery at Site A, and by 1.4% (range 1.2–1.7%) due to iron sand recovery at Site B; and
- Reduce energy flow to the seabed ecosystem averaged over the modelled area by 5.8% (range 3.1–11.9%) by iron sand recovery at Site A, and by 4.1% (range 2.3–8.3%) by iron sand recovery at Site B.

The proportional reduction in benthic PP, and hence fixed carbon flux to the seabed, is expected to occur mostly in an area east of the iron sand recovery operations, where the “median plume” is predicted to move over a relatively shallow (20-40m deep) sandy area, which forms part of the Patea Banks. Here, area-specific reductions of carbon flux to the benthos of up to 40% can be expected.

The optical effects of iron sand recovery on PP by phytoplankton and by MPB are expected to cease shortly after operations stop. As suspended sediment from iron sand recovery operations is fully flushed out of the modelled area (a process predicted to take a few months; Hadfield, 2013) phytoplankton and benthic biomass and PP are estimated to quickly return to background levels.

There is high interannual variability in PP by phytoplankton in the modelled area. Satellite data show that the annual-average chl-a has a standard deviation of 18%. Background interannual variability in phytoplankton PP is likely to be of a similar magnitude. This means that a sustained decrease in phytoplankton PP of 1% due to iron sand recovery operations is very unlikely to lead to ecosystem regime shift (a regime shift is where the community undergoes a fundamental structural change).

There is also high interannual variability in the amount of light reaching the seabed in this locality. Satellite-derived estimates show that the annual-average total light reaching the seabed in the modelled area has a standard deviation of 25%, with annual-averages of between +36% to -32% of the long term mean. This suggests that receiving communities are predisposed to tolerate interannual variability in benthic photosynthesis of magnitudes similar to that expected from iron sand recovery (15–23%), though it will exacerbate low light episodes. Iron sand recovery is unlikely to lead to unnaturally low benthic production in the modelled area that is outside of the envelope of background variability in any given year.

Additional effects of iron sand recovery operations (effects of sediment deposition on the bottom on MPB production and effects of nutrient pore water release by seabed disturbance) are considered to be insignificant, based on modelling and literature information, respectively.

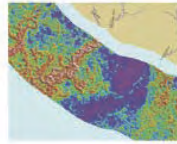
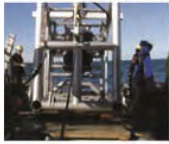

The analyses of the field data, coupled with modelling of the character of the sediment plume from iron sand recovery operations, its trajectory and duration, and its optical effects, and the analyses of these effects on primary production in the modelled area strongly support the conclusion that the overall effects of iron sand recovery on short-lived organisms (living less than a year or two) will be indistinguishable within natural oceanographic variability. Effects at local scale proximal to the iron sand recovery operations will be limited to decreases in MPB production and organic carbon availability to benthic consumers. This may exceed natural variability and may propagate locally to organisms that feed primarily on MPB and in turn to their predators.

Further refinement of the above assessments would require collecting substantial additional field data, particularly regarding the magnitude of benthic production across the Patea Banks. The inherent variability in the relevant oceanographic variables and the dynamic nature of the South Taranaki Bight itself, mean that this would require a long and expensive field campaign. TTR's advisors do not consider this to be necessary and have expressed confidence that their assessments represent sound science that lie well within the bounds of reasonable probability.

6. OVERALL SUMMARY

The re-modelling by NIWA and subsequent interpretation of effects following the scientific assessments undertaken by internationally recognised experts fundamentally recasts the understanding of the scale and extent of the potential environmental effects associated with the recovery of iron sand from the seabed of the South Taranaki Bight. The plume associated with iron sand recovery will produce changes in sediment concentrations that are within the range of natural variability at the scale of the modelled domain or the wider South Taranaki Bight and will not result in any ecologically significant adverse effects on primary productivity or fixed carbon flux to marine ecosystems at the large scale. Significant localised effects may occur but these would be patchy and episodic in nature and the ecosystem would recover once the recovery activities progress or stop.

TTR looks forward to discussing the project and answering any questions regarding the new modelling and scientific assessments with key stakeholders. A representative of TTR will make contact with you in the near future to arrange a convenient time to commence these discussions.

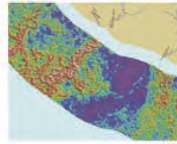
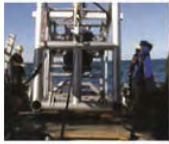

7. References

Cahoon, L.B.; Erin S. Carey and James H. Blum. (2012). Benthic microalgal biomass on ocean beaches: Effects of sediment grain size and beach renourishment. *J. Coastal Research* 28: 853-859.

Cahoon, L.; Pinkerton, M.; Hawes, I. (2015). Effects on primary production of proposed iron sand sediment recovery in the South Taranaki Bight region. Report prepared for Trans-Tasman Resources Ltd.

Hadfield, M.; Macdonald, H. (2015). Sediment plume modelling: revised calculations. NIWA Client Report No. WLG2015-22, 69 p.

HR Wallingford (2014a). Support to Trans-Tasman Resources: Independent Review of Plume Modelling. DDM7316-RT001-R01-00. 54 p.

HR Wallingford (2014b). Support to Trans-Tasman Resources: Laboratory Testing of Sediments. DDM7316-RT002-R01-00. 27 p.

HR Wallingford (2015). Support to Trans-Tasman Resources: Analysis of Source Terms for Plume Dispersion Modelling. DDM7316-RT003-R01-00. 28 p.

MacDiarmid, A.; Gall, G.; Stewart, R.; Robinson, K.; Fenwick, M. (2015). Zooplankton communities and surface water quality in the South Taranaki Bight February 2015. NIWA Client Report No. WLG2015-25, 22 p.

MacDiarmid, A.; Thompson, D.; Gieve, J. (2015). Assessment of the scale of marine ecological effects of seabed sediment recovery in the South Taranaki Bight: Zooplankton, fish, kai moana, sea birds, and marine mammals 2015. NIWA Client Report No. WLG2015-13, 107 p.

Pinkerton, M.; Gall, M. (2015). Optical effects of proposed iron-sand sediment recovery in the South Taranaki Bight region. NIWA Client Report No. WLG2015-26 rev 2, 79 p. September 2015.

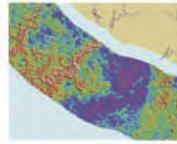

8. Appendix 1: Supplementary Science Layout

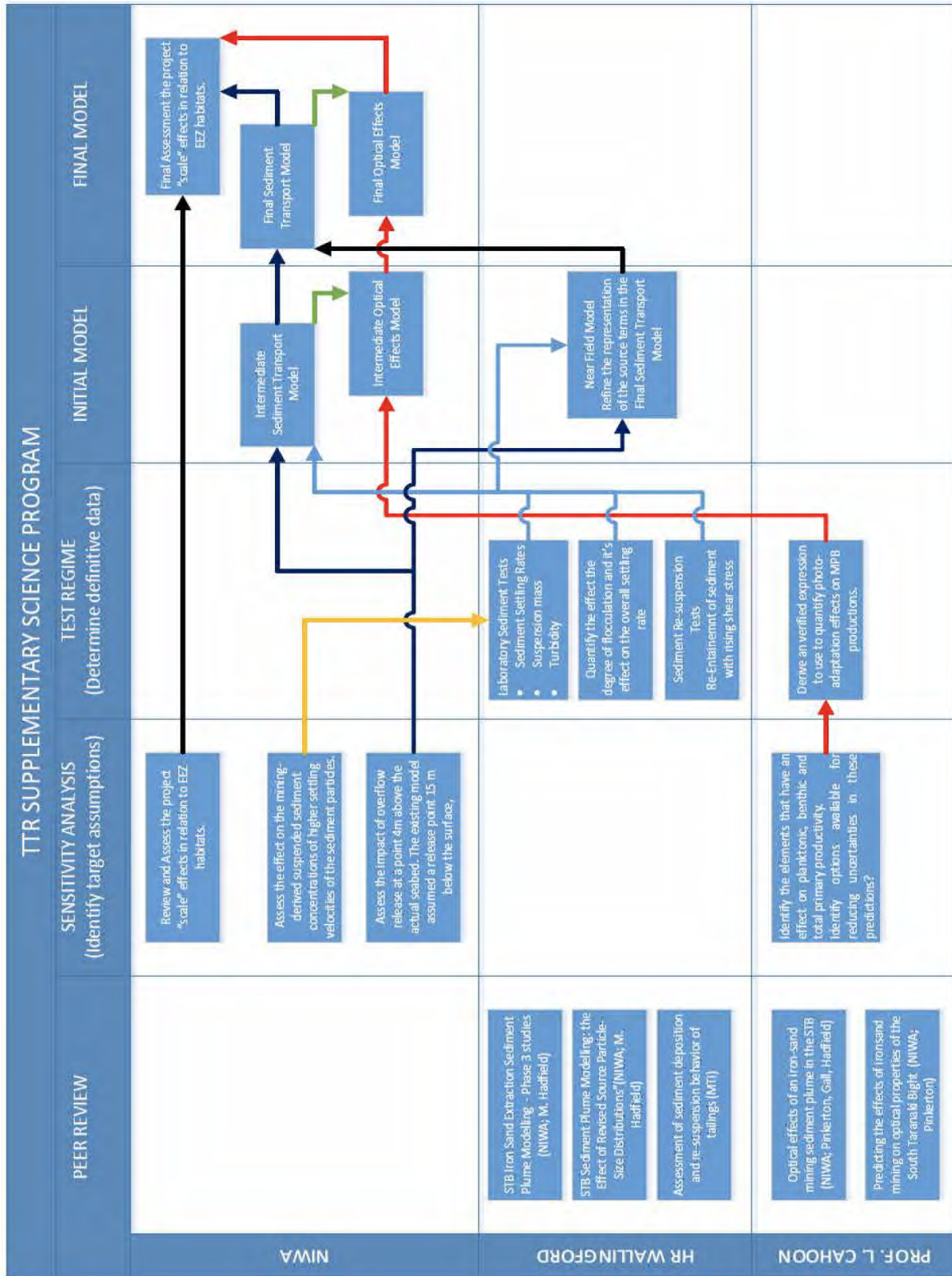



TTRL OFFSHORE IRON SANDS PROJECT

ECONOMIC IMPACT ANALYSIS SUMMARY

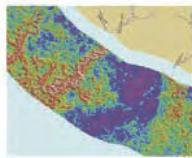
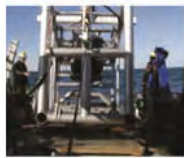

1. INTRODUCTION

Martin Jenkins was engaged in 2015 to undertake an economic impact analysis of Trans-Tasman Resources Limited's (TTR) proposed iron sands project on the local (South Taranaki/Whanganui), regional (Taranaki/Whanganui), and national (New Zealand) economies. The economic impact is assessed by applying regional Input-Output Multipliers to TTR's projected operational expenditure in several industry areas in order to measure the direct, indirect and induced GDP and employment impacts.

The economic impact analysis shows that TTR's proposed iron sands project will have a positive economic impact on the South Taranaki, Whanganui and New Plymouth districts as well as contributing to the New Zealand economy through royalties, taxes and export earnings. The project complements existing industries in the region and will encourage high value economic activity in an area facing economic decline.

2. PROJECT

The iron sands project aims to extract iron ore from iron sand on the Taranaki Bight, in an area which is from 22 to 37 kilometres off the coast of South Taranaki. The iron ore will then be exported to international markets. TTR has a 20 year mining permit and the project is expected to extract 5 million tonnes of iron ore per annum.

The operational expenditure for the project is estimated be about \$254 million annually. About \$133 million of that annual expenditure will be spent in New Zealand. Of that about \$73 million is expected to be spent in the Taranaki/Whanganui region, with \$35 million spent directly in the South Taranaki and Whanganui districts each year.

2.1 Study area

The analysis looked at the economic activity within three study areas – local, regional and national. The local study area consists of South Taranaki and Whanganui. It is where the iron sands operations will occur. The regional study area is made up of four local authorities - South Taranaki, Whanganui, Stratford, and New Plymouth. A large portion of expenditure will be within this regional study area. The national study area is New Zealand.

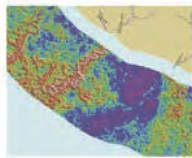
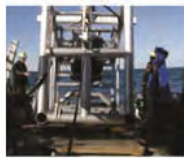

3. LOCAL DEVELOPMENT

The main area of activity is likely to be in South Taranaki and Whanganui. This is a relatively small economy in a rural area where the effects of a project will have a noticeable impact on the local economy, particularly as new jobs are generated. While there is oil and gas and extraction activity in South Taranaki, much of this is serviced out of New Plymouth, limiting the benefits to the local region.

TTR has indicated that it is looking to have as much positive impact on the local area as it possibly can. This includes establishing support functions in the rural area (rather than basing it in New Plymouth), utilising local services where possible (i.e. engineering services), and working with the community to encourage participation from the local workforce.

TTR recognises the benefits to the operation and to the region from employing local people where feasible. Investing in training to employ local people will benefit the individuals, the community, and ultimately the project itself.

TTR envisages that, at project initiation, approximately 30 percent of all TTR employed persons would be New Zealand citizens with approximately 10 percent of those being from local South Taranaki and Whanganui communities. It is TTR's aspiration that after five years of operation, sufficient technology and skills transfer has taken place that 80 percent of the people employed directly will be New Zealand citizens and that a significant proportion of those would be from South Taranaki/Whanganui communities.

To achieve this, TTR is exploring the possibility of basing a training school in South Taranaki, working with an ITP and regional businesses to assess the viability.

Long term, main contractors and service suppliers will also be required to ensure a progressively increasing local quota with regards to people employed within their organisation working on the TTR operation. These contractors and service suppliers will also be required to include local firms on tender lists.

The Geotechnical Services Vessel would be based out of Whanganui harbour, with its supporting onshore activities also based in Whanganui, providing much needed activity in the local area. A potential opportunity exists to develop a heli-port in Hawera or Opunake, which would provide services to offshore activity.

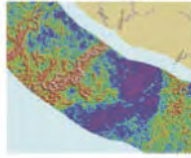

4. THE ECONOMIC IMPACT

The analysis is underpinned by projected operational expenditure from the project in several study areas and applying established regional Input-Output Multipliers to measure the direct, indirect and induced GDP and employment impacts.

The total economic impact of the iron sands project on the local, regional and national economies is shown in the following table. Expenditure and GDP are per annum, while Employment is the number of jobs supported.

Total impact by study area	Expenditure \$m	GDP \$m	Em ploy ment FTEs
Local	45.1	18.6	299
Regional	115.7	50.6	705
National	349.1	159.0	1,666

Source: Martin Jenkins

Local (South Taranaki/Whanganui)

The iron sands project is expected to generate about \$18.6 million in GDP and employ 299 people in the South Taranaki/Whanganui economy each year over 20 years.

Regional (Taranaki/Whanganui)

The iron sands project is expected to generate about \$50.6 million in GDP and employ 683 people in the Taranaki/Whanganui economy each year over 20 years.

New Zealand

The iron sands project is expected to generate about \$159 million in GDP and employ 1,666 people in the New Zealand economy each year over 20 years.

The project will also contribute to government income through royalties and taxes and to New Zealand's export earnings. At a conservative price of US\$40/tonne and a NZ\$/US\$ exchange rate of \$0.65, the project would contribute \$6.15 million in royalties and about \$312 million in export earnings each year. Government would also collect taxes from the venture.

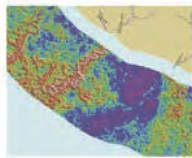
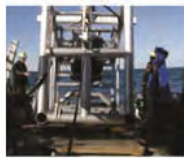

The price of iron ore is unlikely to affect the economic impact analysis. The bulk of the economic impacts arise from the expenses associated with the project. Price rises will lead to greater royalties, taxes and profits, but these are less important contributors to economic impact than operational costs. If iron ore prices fall, the royalties, taxes and profits will decline, but the economic impact will continue to occur until the price falls below the break-even point for a prolonged period forcing the project to cease operations.

5. WIDER BENEFITS

The iron sands project will have a significant effect on the South Taranaki and Whanganui economies. It would add to the diversification of economic activity in the region, which is heavily reliant on the oil and gas and dairy sectors. This would improve the resilience of the region, where the key sectors are prone to global commodity prices and cycles. At the same time, the services required by the project are complementary to existing services demanded in the region, ensuring that local businesses will participate in and benefit from the activity. The location of the project in South Taranaki and Whanganui would encourage much needed activity in an area that is not performing well economically.

We at TTR are well aware of the potential to make a meaningful contribution to the local economy. We recognise that a local focus will make for a more stable and successful business. We are seeking to encourage and support as much local engagement as reasonably and financially possible, both with regards to our own activity and also the services we purchase from out-of-region providers. Own activities include encouraging servicing activity within the area, exploring the potential for setting up a training facility, and local labour content targets. Our main suppliers will also be set local labour content targets.

6. REFERENCES

MartinJenkins 2015, "ECONOMIC IMPACT ANALYSIS OF THE IRON SANDS PROJECT"
South Taranaki/Whanganui; Taranaki/Whanganui; New Zealand

ECONOMIC IMPACT ANALYSIS OF TRANS-TASMAN RESOURCES OFFSHORE IRON SANDS PROJECT

South Taranaki/Whanganui; Taranaki/Whanganui; New
Zealand

30 October 2015



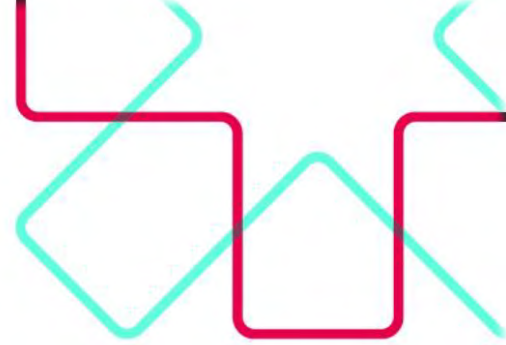

CONTENTS

Executive Summary	1
Introduction	4
Background	4
Method	4
Limitations	9
Report structure	10
The study areas	11
TTR's Proposed Iron Sands Project	14
Iron sand	14
Activity	14
Operating activities	15
Potential initiatives to encourage local activity	17
TTR direct employment	18
TTR direct expenditure	19
Economic Impact Analysis	21
Local (South Taranaki/Whanganui)	21
Regional (Taranaki/Whanganui)	22
New Zealand	23
Other quantitative impacts	24
Qualitative Impacts	27
Complementarity and diversification	27
Local development	28
Potential Negative Impacts	29
Visitors	29
Commercial fishing	30
Recreational fishing	30
Summary of economic costs	31
References	32



APPENDICES

Appendix 1 : Regional I-O Multiplier analysis

33

TABLES

Table 1:	List of abbreviations	5
Table 2:	Map of the local and regional study areas	11
Table 3:	Study area metrics, 2004 to 2014	12
Table 4:	Benefits by area, June 2015	12
Table 5:	TTR personnel	18
Table 6:	Operational expenditure by industry, annual average	19
Table 7:	Economic impact of activity on the South Taranaki district	21
Table 8:	Economic impact of activity on the Taranaki/Whanganui region	22
Table 9:	Economic impact of activity on New Zealand	23
Table 10:	New Zealand's principal exports, year to June 2015	26
Table 11:	Visitor expenditure, 2009 - 2014	29
Table 12:	Addressing the limitations of regional I-O multiplier analysis	34

FIGURES

Figure 1:	Economic benefits of the TTR iron sands project	3
Figure 2:	NZ\$/US\$ exchange rate, 2006 to 2015	6
Figure 3:	Heavy Fuel Oil spot price, 1990 to 2015	7
Figure 4:	Iron ore spot prices, 1990 to 2015	8
Figure 5:	Map of the iron sands project permit area	14
Figure 6:	Royalties and taxes	24



ACRONYMS

Table 1: List of abbreviations

Abbreviation	
AHT	Anchor Handling Tug
BGA	Business Growth Agenda
EIA	Economic Impact Analysis
FSO	Floating Storage and Offloading Vessel
FTEs	Full Time Equivalents
GDP	Gross Domestic Product or value added
GSV	Geotechnical Survey Vessel
HFO	Heavy Fuel Oil
IMV	Independent Mining Vehicle
I-O	Input-Output
ITP	Industry Training Provider
TTR	Trans-Tasman Resources Limited



PREFACE

This report has been prepared for Trans-Tasman Resources Limited by Jason Leung-Wai from MartinJenkins (Martin, Jenkins & Associates Limited). Nick Davis provided internal peer review.

MartinJenkins advises clients in the public, private and not-for-profit sectors, providing services in these areas:

- Public policy
- Economic development
- Evaluation and research
- Strategy and investment
- Performance improvement and monitoring
- Organisational improvement
- Employment relations
- Financial and economic analysis.

Our aim is to provide an integrated and comprehensive response to client needs – connecting our skill sets and applying fresh thinking to lift performance.

MartinJenkins is a privately owned New Zealand limited liability company. We have offices in Wellington and Auckland. The company was established in 1993 and is governed by a Board made up of executive directors Doug Martin, Kevin Jenkins, Michael Mills, Nick Davis and Nick Hill, plus independent directors Peter Taylor (Chair) and Sir John Wells.



EXECUTIVE SUMMARY

Trans-Tasman Resources' (TTR) proposed offshore iron sands project will have a positive economic impact on the South Taranaki, Whanganui and New Plymouth districts. The project will also make a significant contribution to the New Zealand economy through royalties, taxes and export earnings. The project complements existing industries in the region and will encourage high value economic activity in an area facing economic decline.

MartinJenkins was commissioned to undertake an economic impact analysis of the iron sands project on the local (South Taranaki and Whanganui), regional (South Taranaki, Whanganui, New Plymouth and Stratford) and national economies. The economic impact is based on Regional Input-Output Multiplier Analysis, which is an established and accepted approach to estimating economic impacts in a defined area from an activity.

The iron sands project

The iron sands project aims to extract iron ore from iron sand from the seabed of the South Taranaki Bight, in an area which is between 22 and 37 kilometres off the coast of South Taranaki. The iron ore will then be processed at sea and exported to international markets.

TTR has a 20 year mining permit and the project is expected to recover 5 million tonnes of iron ore per annum. The operational expenditure for the project is estimated to be approximately \$254 million annually. About \$133 million of that annual expenditure will be spent in New Zealand. Of that approximately \$73 million is expected to be spent in the Taranaki/Whanganui region, with \$35 million spent directly in the South Taranaki and Whanganui districts each year.

The economic impact

The analysis in this assessment is underpinned by projected operational expenditure from the project in several study areas and applying Regional Input-Output Multiplier Analysis to measure the direct, indirect and induced GDP and employment impacts.

The total economic impact of the iron sands project on the local, regional and national economies is shown in the following table.

Total impact by study area	Expenditure \$m	GDP \$m	Employment FTEs
Local	45.1	18.6	299
Regional	115.7	50.6	705
National	349.1	159.0	1,666

Source: MartinJenkins

Each year the iron sands project is estimated, at the:

- local level, to generate an additional \$45.1 million in expenditure, generating \$18.6 million in GDP and supporting 299 jobs



- regional level, to generate an additional \$115.7 million in expenditure, generating \$50.6 million in GDP and supporting 705 jobs
- national level, to generate an additional \$349.1 million in expenditure, generating \$159 million in GDP and supporting 1,666 jobs.

The project will also contribute to Government income through royalties and taxes and to New Zealand's export earnings. At a conservative price of US\$40/tonne and a US\$/NZ\$ exchange rate of \$0.65, the project would contribute \$6.15 million in royalties and about \$312 million in export earnings each year. Government would also collect taxes from the venture.

The price of iron ore is unlikely to affect the economic impact analysis. The bulk of the economic impacts arise from the expenses associated with the project. Price rises will lead to greater royalties, taxes and profits, but these are less important contributors to economic impact and more unpredictable to forecast than operational expenditure. If iron ore prices fall, the royalties, taxes and profits will decline, but the economic impact will continue to occur until the price falls below the break-even point for a prolonged period forcing the project to cease operations.

Wider benefits

The iron sands project will have a significant effect on the South Taranaki and Whanganui district economies. The location of the project in South Taranaki and Whanganui would encourage much needed activity in an area that is not performing well economically.

The project would add to the diversification of economic activity in the Taranaki/Whanganui region, which is heavily reliant on the oil and gas and dairy sectors. The project would improve the resilience of businesses in the region, where the key sectors are prone to global commodity prices and cycles. At the same time, the services required by the project are complementary to existing services demanded in the region, ensuring that local businesses will participate in and benefit from the activity.

TTR is well aware of their potential to make a meaningful contribution to the local economy. They recognise that a local focus will make for a more stable and successful business. TTR is seeking to encourage and support as much local engagement as reasonably and financially possible, both in their own activity, but also the services they purchase from out-of-region providers. Their own activities include encouraging servicing activity within the area, exploring the potential for setting up a training facility, and local labour content targets. Their main suppliers will also be set local labour content targets.



Figure 1: Economic benefits of the TTR iron sands project

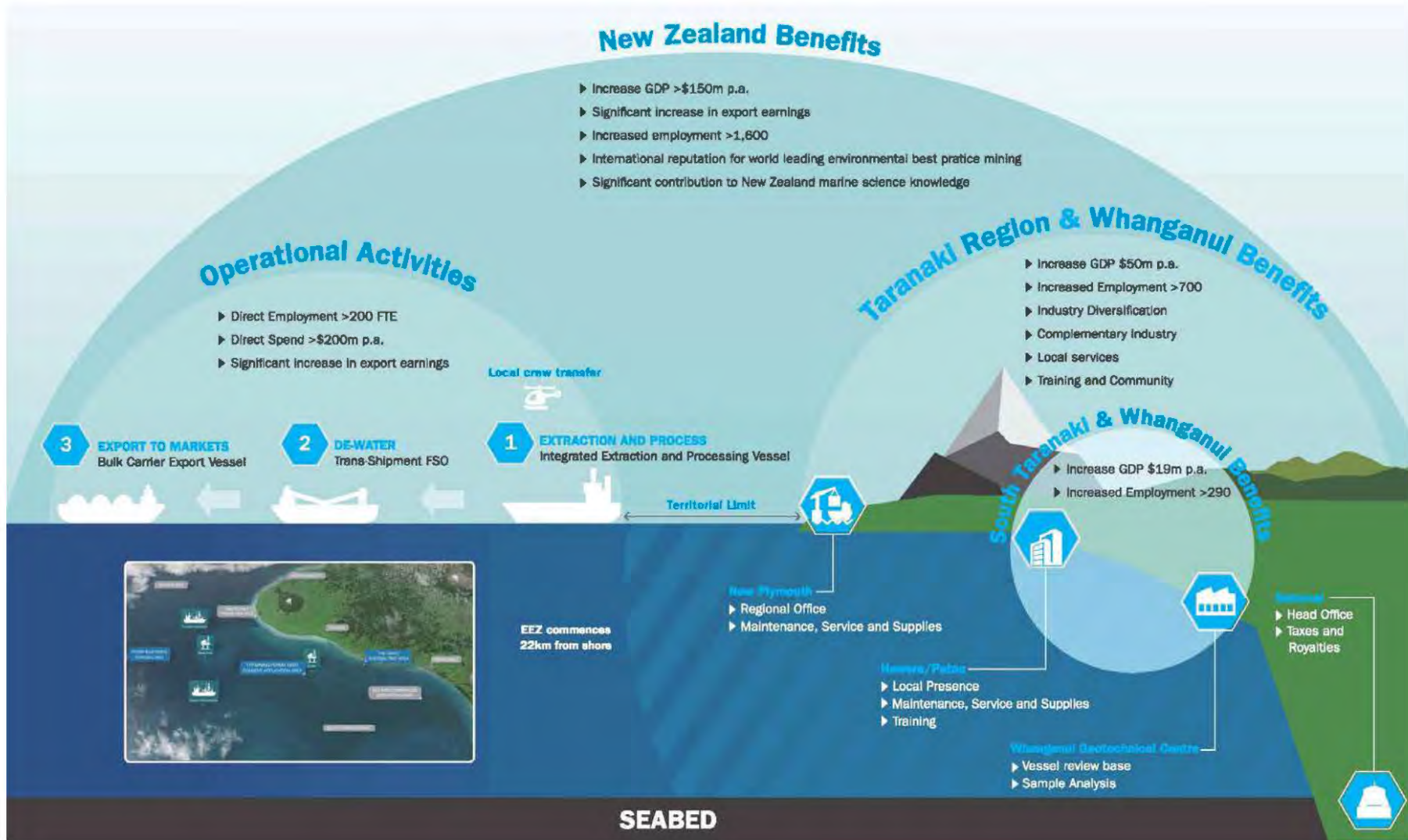

INTRODUCTION

MartinJenkins has been engaged to undertake an economic impact analysis of Trans-Tasman Resources Limited's (TTR) proposed offshore iron sands project on the local (South Taranaki/Whanganui), regional (Taranaki/Whanganui), and national (New Zealand) economies.

Background

TTR is investigating an iron sands mining project off the west coast of South Taranaki. Based on a 20 year operational lifespan, it is expected that the project will have a positive impact on the study areas in terms of economic activity (expenditure and GDP) and jobs.

The project will also have qualitative impacts on the study areas in relation to:

- improving the resilience of the economy by providing diversification in a complementary area of activity
- encouraging regional economic development through operating as much as financially reasonably possible in the local area, engaging with the local community and encouraging local training and employment in the project.

There are also benefits to New Zealand through increasing exports, generating royalties on the mineral resource and meeting statutory and regulatory contributions including payment of taxes.

Method

The report identifies the economic impact at the local, regional and national levels as a result of the activity generated by the iron sands project.

Regional input-output multiplier analysis

The underpinning method is Input-Output (I-O) Multiplier Analysis, which estimates the economy-wide effects that an initial change in economic activity has on a particular economy.

Regional I-O tables and multipliers are constructed from a detailed set of industry accounts that measure the commodities produced by each industry and the use of these commodities by other industries and final users within the region. An initial change in economic activity results in diminishing rounds of new spending as leakages occur through saving or spending outside the region.

The economic impact analysis follows the accepted practice of identifying the impact from the direct expenditure associated with the project and then applying regional multipliers¹ to determine the indirect and induced effects of that initial expenditure in terms of gross output, value added (GDP), and employment.²

¹ There is no official set of regional input-output tables. Regional tables are calculated by several private providers. The input-output tables and multipliers used in this analysis were generated by Butcher and Partners limited and are based on the latest national input-output tables. Butcher and Partners are acknowledged and respected providers of regional input-output tables, which have been used in numerous economic impact studies in New Zealand over the years.

² Gross output, value added and FTE employment are defined in the appendix on p 33.



Direct impacts are those that are initially generated by the initial expenditure with businesses. Indirect impacts occur when those initial businesses purchase materials, goods and services from supplier firms, who in turn make further purchases from their suppliers and so forth. Induced impacts occur when employees in those businesses providing the materials, goods and services are paid wages and the enterprises generate profits that are then spent on consumption within the region.

Operational expenditure is assigned to the appropriate industry category and ratios and multipliers are applied. The totals for each industry are aggregated to provide the direct, indirect and induced economic impacts in terms of gross output (expenditure), value added (GDP) and employment (FTEs). Where estimates of direct employment are known, these are incorporated directly into the model (the employment to output ratio is over-ridden).

This approach is consistent with that used in a recent report on the economic impact of the oil and gas sector on the Taranaki and New Zealand economy (Venture Taranaki, 2015).

Economic activity

Direct activity is measured in terms of annual average operational expenditure. This has been provided directly by TTR and is derived from their business plan.

As well as expenditure, we have incorporated estimates of direct employment by TTR and by major suppliers to service the operation (such as for fuel bunkering). This provides a more accurate assessment of the likely employment impacts as a result of activity.

The analysis does not include economic activity from the initial set up and construction costs of the iron sands project. Nor does it include expenditure from the royalties and taxes paid by TTR to the government.

Study area

The report looks at the economic activity within three study areas – local, regional and national. The local study area consists of South Taranaki and Whanganui. It is where the iron sands operations will occur. The regional study area is made up of four local authorities - South Taranaki, Whanganui, Stratford, and New Plymouth. A large portion of expenditure will be within this regional study area. The national study area is New Zealand.

Prices

All prices are expressed in nominal New Zealand Dollars unless otherwise noted.

Exchange rates and fuel cost assumptions

The analysis is based on operational expenditure, which is less exposed to changes in exchange rates and commodity prices. However, there is still a large import component as Heavy Fuel Oil (HFO) is a major cost. Overseas expenditure is based on a NZ\$/US\$ exchange rate of 0.65. HFO is factored in at \$350/t.

Historical trends in the NZ\$/US\$ exchange rate and HFO prices are shown in the following two figures.



Figure 2: NZ\$/US\$ exchange rate, 2006 to 2015

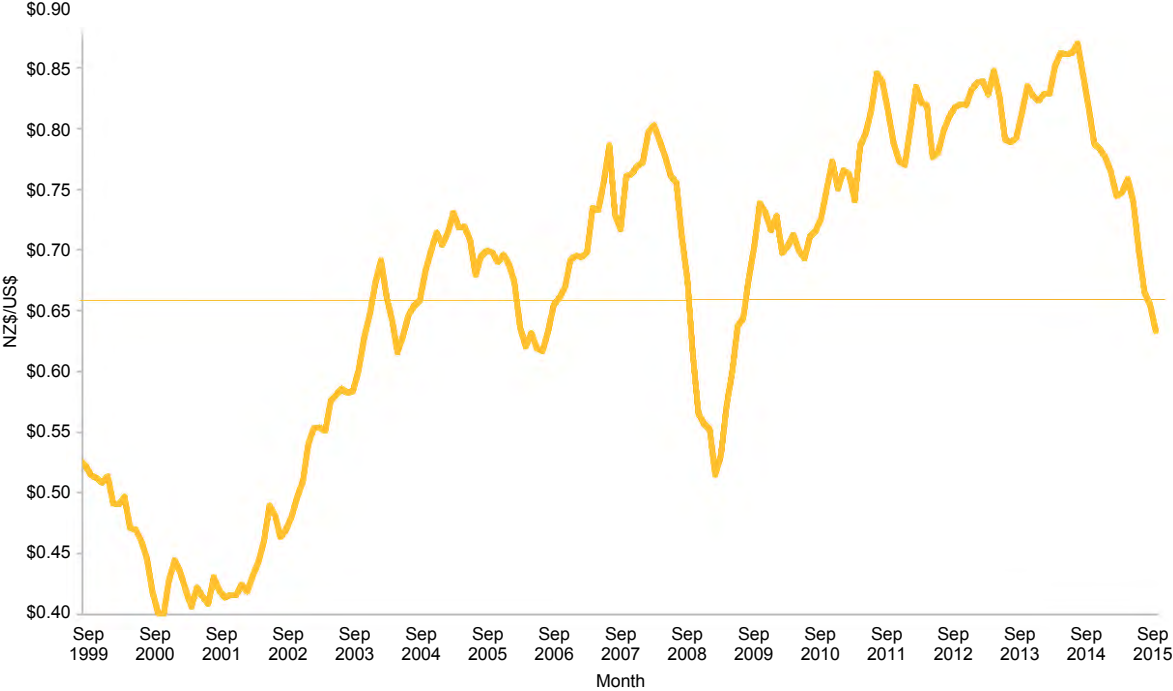

Source: Reserve Bank New Zealand

Over the last 10 years the New Zealand dollar has fluctuated within a fairly broad range of US\$0.52 to US\$0.87. Over the last 15 years, the average exchange rate has been US\$0.66, while over the last 10 years it has averaged US\$0.74. Most recently it has been declining from an historical high and is currently fluctuating between US\$0.63 and US\$0.66.

Volatility and short term fluctuations aside, we consider that the NZ\$/US\$ rate of 0.65 used in the analysis is reasonable and conservative. Ultimately, the analysis captures New Zealand operating expenditure in New Zealand dollars and so therefore fluctuations in the exchange rate will have only minor effects on the economic impact.



Figure 3: Heavy Fuel Oil spot price, 1990 to 2015

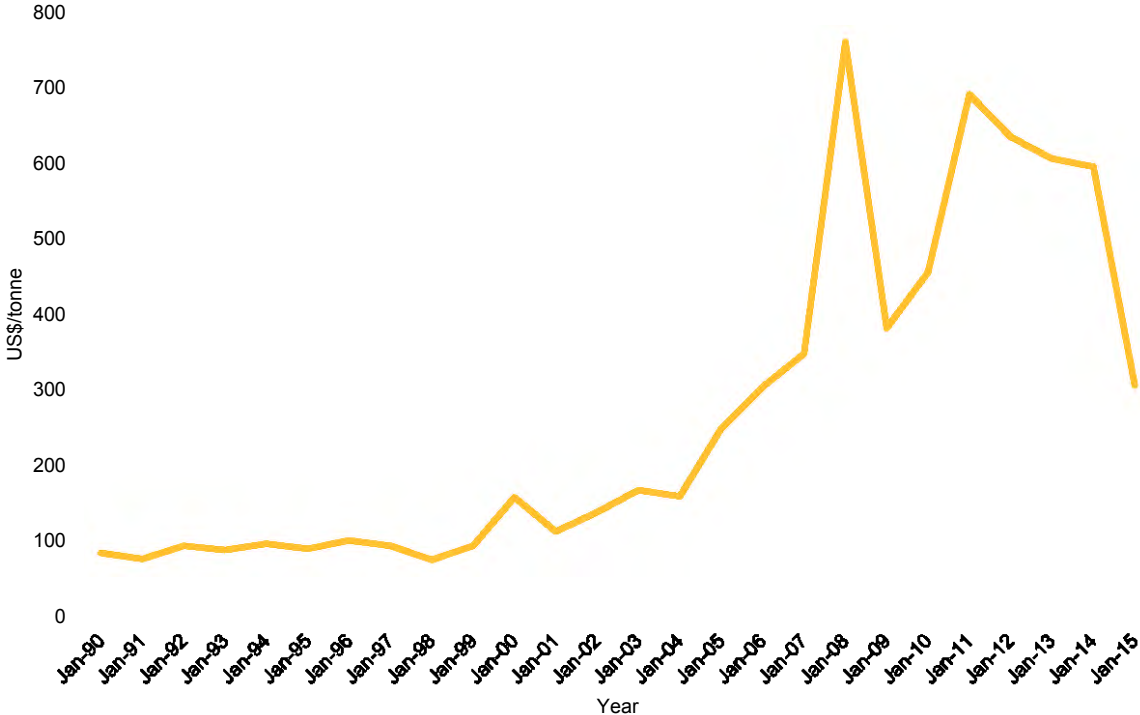

Source: National Institute of Statistics and Economic Studies (Insee)

The price of HFO stayed relatively constant over the 1990’s before increasing over the 2000’s, peaking at US\$760/tonne before contracting sharply as a result of the global financial crisis. Prices had almost recovered before they started easing off in 2011. There has been a rapid fall over the last two years with the latest price being US\$307/tonne (July 2015).

Looking ahead, HFO prices correlate to movements in crude oil prices, which are expected to stay subdued over the short to medium term. However, as noted earlier, the analysis is capturing the benefits from the level of activity rather than the price of inputs. Volumes are unlikely to change over time so operational activity and economic activity will not be significantly affected by changes in HFO prices.

Royalties and taxes

TTR is a permit holder and must pay to the Crown royalties in respect of all minerals obtained under that permit that are sold, used in the production process, are otherwise exchanged or removed from the permit without sale, or remain unsold on the surrender, expiry or revocation of the permit. The holder of a mining permit must pay the higher of –

- 1 An *ad velorem* royalty of 2 percent of the net sales revenue of the minerals obtained under the permit and



- 2 An accounting profits royalty of 10 percent of the accounting profits, or provisional accounting profits, as the case may be, of the minerals obtained under the permit.

As a New Zealand corporate, TTR will also have to pay company tax. The maximum company Income Tax rate is 28 percent. New Zealand tax resident employees also pay tax on wages and salaries at rates up to 33 percent.

While the focus of the analysis is on expenditure, if revenues increase, then economic contribution in terms of royalties and taxation of the iron sands project will also increase. The contribution to royalties and taxation are influenced by exchange rate and input costs, but they are mostly dependent upon the price of iron ore concentrate.

Figure 4: Iron ore spot prices, 1990 to 2015

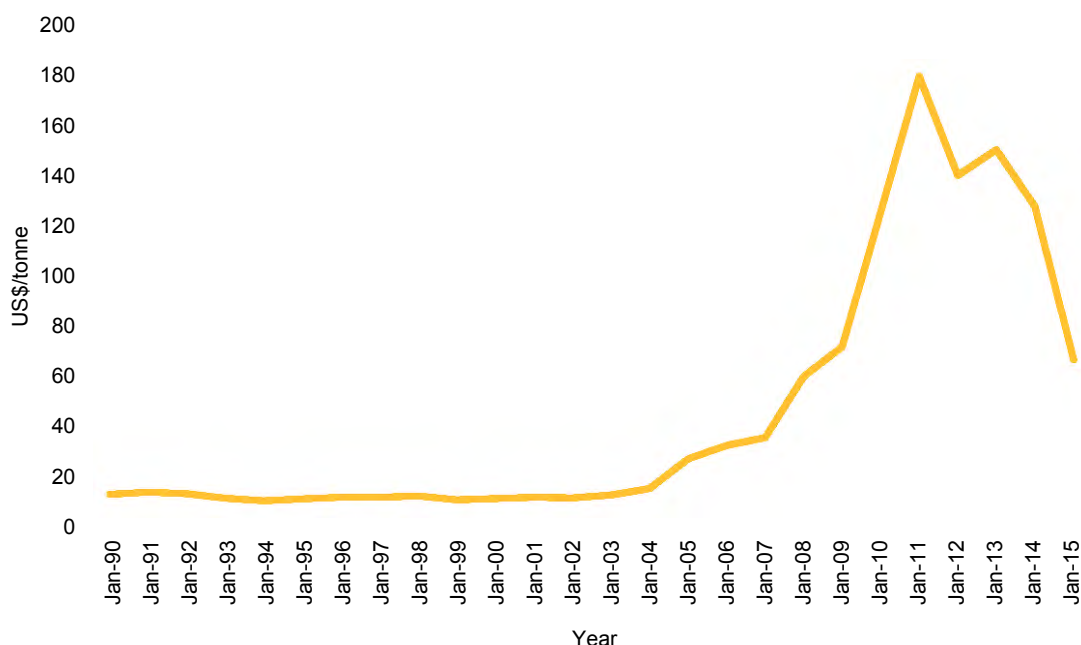

Source: National Institute of Statistics and Economic Studies (Insee)

Note: Iron ore – Chinese imports, Tianjin Port, Spot price – CIF, 62% Fe type. TTR iron sand is slightly different in that the iron ore content is 58%. Prices will be benchmarked against the Platts TSI 58 index price, which is a relatively new index. However, the trend in prices is likely to be relatively consistent with the above analysis.

The index price for iron ore stayed constant over the 1990s and into the early 2000's before increasing exponentially, peaking in January 2011 at US\$180/t. Since then the index price fell to just over US\$50/t in July 2015 and at the time of this report is approximately US\$55/t.

The general consensus is that prices over the short to medium term will ease slightly due to oversupply in the market and reduced demand out of China. UBS forecasts a long-term iron ore price



of US\$55/t, while Goldman Sachs has forecast prices to drop to US\$40/t in 2017/18.³ The World Bank has forecast iron ore prices of US\$75/t in 2025.⁴

The price of iron ore is unlikely to affect the economic impact analysis. The bulk of the economic impacts arise from the expenses associated with the project. Price rises will lead to greater royalties, taxes and profits, but these are less important contributors to economic impact and more unpredictable to forecast than operational expenditure. If iron ore prices fall, the royalties, taxes and profits will decline, but the economic impact will continue to occur until the price falls below the break-even point for a prolonged period forcing the project to cease operations.

Limitations

Regional I-O Multiplier Analysis limitations

Regional I-O Multiplier Analysis is a static model that does not allow for price changes resulting from activity. Further the approach requires that economic activity applied to the model is additional to existing activity and that it does not include displaced activity from other areas of the economy.

While this project is significant, we do not consider that its operations will result in price changes. There are four reasons why we have come to this conclusion.

- 1 The activity will be additional as it is utilising a resource that currently has no economic value.
- 2 The project is relatively niche and so it will attract global capital that is unlikely to displace existing or potential projects.
- 3 There is currently excess capacity in the market so support activity can be absorbed without putting upward pressure on prices. Also, in the initial phases, employment will likely be filled from the international market. Very senior roles likely to be advertised are specialist positions and are unlikely to be sourced/filled from existing employees in the region.
- 4 Iron ore is a globally traded commodity. As a very small player (<1%), TTR entering the market will not have any influence on international prices for iron ore.

How this analysis addresses the limitations of I-O Multiplier analysis is presented in a table on page 34.

Accuracy of the Regional I-O Multipliers

The smaller the geographic area being assessed and the more aggregated the analysis of industries, the less accurate the model.

Our view is that the Taranaki region is a relatively isolated region with a strong supporting services industry built around energy and the dairy sector. As a result, the intermediate production and

³ (Els, 2015) www.mining.com/iron-ore-price-rally-turns-into-dead-cat-bounce/. Published 29 April 2015. Downloaded on 09 September 2015

⁴ (World Bank, 2015). World Bank Commodities Price Forecast (nominal US dollars). Released July 20, 2015.



leakages out of the region are clearer than for many other regions of New Zealand. For the same reasons, leakage out of South Taranaki is likely to be into New Plymouth.

Industry accuracy is enhanced by assigning expenditure into the appropriate industry rather than lumping it all into a single associated industry. This ensures that the multipliers and relationships between expenditure, GDP and output are as accurate as possible. Second, in our analysis we have incorporated estimates of direct employment where applicable. This ensures that our employment multipliers are consistent with our understanding of the likely level of employment activity.

There are no official regional I-O tables. There are several private sector providers of regional I-O tables. This analysis uses regional I-O tables supplied by Butcher Partners. Butcher Partners is a recognised supplier of regional tables that have been used in a number of economic impact analysis studies of industries and events throughout the regions of New Zealand.

Report structure

The report is split into three sections. The next section explores the economic activity likely to occur as a result of the iron sands project. It includes a description of the likely activity and provides a breakdown of estimated annual expenditure and direct employment by TTR.

From there we undertake the economic impact analysis. This uses average expenditure and employment estimates to calculate the direct, indirect and induced impacts of the iron sands project on the South Taranaki/Whanganui districts, Taranaki/Whanganui region, and New Zealand economies. It also explores the contribution of the project to New Zealand through royalties, taxes and exports.

The final section explores the wider impacts of the iron sands project on the area. These wider impacts are not quantifiable but rather demonstrate how the iron sands project aligns to, and improves economic sustainability and resilience in the South Taranaki and Whanganui districts and the wider Taranaki region. There is also a brief discussion on the cost of potential negative impacts on tourism and commercial and recreational fishing.



THE STUDY AREAS

There are three study areas where we consider the economic impact. The local area (Whanganui and South Taranaki district councils), the region area (the local area plus New Plymouth and Stratford district councils), and the country area (the whole of New Zealand).

The local area is a largely rural, agrarian-based economy in the hinterland of the western coast of the North Island.

In the region area, New Plymouth is the main service centre for the Taranaki region. Hawera is a smaller service centre in South Taranaki. Whanganui has a relatively large town centre, with people either travelling south to Palmerston North, or north to New Plymouth for the next tier of services.

Both South Taranaki and Whanganui have been experiencing a decline in economic activity over the last ten years in terms of population and GDP, while employment has been static. Unemployment is relatively high, particularly in Whanganui. This is reflected in the relatively high proportion of beneficiaries in the region.

The Taranaki economy has been led by growth in New Plymouth, on the back of good performances in the dairy and oil and gas sectors and subsequent improvements in the liveability of the district. The New Plymouth District has seen population, employment and GDP growing faster than the New Zealand average over the last ten years. When other districts in the study area are incorporated, growth across all indicators is below that for New Zealand as a whole.

Table 3 looks at three metrics of growth in the study areas over the last ten years – population, employment and GDP.

Table 2: Map of the local and regional study areas



Source: Local Government New Zealand



Table 3: Study area metrics, 2004 to 2014

Study area	Population 2014	%pa Growth 04-14	Employment 2014	%pa Growth 04-14	GDP \$m	%pa Growth 04-14
South Taranaki/Whanganui	70,900	-0.1%	32,432	0.0%	3,761	-0.5%
Taranaki region/Whanganui	158,360	0.5%	75,269	0.9%	10,757	1.3%
New Zealand	4,509,900	1.0%	2,229,679	1.2%	241,262	1.8%

Source: Infometrics Regional Database

The South Taranaki/Whanganui area has not done as well as the wider Taranaki/Whanganui area, which has not done as well as New Zealand as a whole.

The South Taranaki/Whanganui area has a population of just under 71,000, provides employment for 32,400 people and contributes \$3.5 billion to GDP. The population has been declining over the last ten years by 0.1 percent annually. Employment has remained static, while GDP has fallen by 0.5 percent per annum.

At the Taranaki/Whanganui area level, the metrics have been positive. The population of 158,400 has been growing by 0.5 percent annually over the last ten years. Employment has grown even faster at 0.9 percent per annum, while GDP has growth at 1.3 percent per annum. However, the rates of growth are below the New Zealand average, with population growing at half the national rate and employment and GDP at close to 75 percent of the national rate.

Table 4 shows the number of people on a benefit in the different study areas in June 2015.

Table 4: Benefits by area, June 2015

	Jobseeker	Sole Parent	Supported Living	Other Main Benefits	Total
Hawera	542	366	541	11	1,460
Whanganui	2,192	1,121	1,677	68	5,058
South Taranaki/Whanganui	2,734	1,487	2,218	79	6,518
Taranaki/Whanganui	4,313	2,344	4,083	88	11,117

Source: Ministry of Social Development

Over 2,700 people were looking for work in the South Taranaki/Whanganui study area. The majority of these (80 percent) were based in Whanganui.

A further 1,580 people were on a jobseeker benefit in the New Plymouth district. At the Taranaki/Whanganui area there were a total of 4,300 people looking for work.

Recent labour market statistics are not available at the district level. However, at the 2013 census Whanganui had an unemployment rate of 9.6 percent and a participation rate of 60.5. In South Taranaki, the unemployment rate was 5.8 percent and the participation rate was 68.4. For the



Taranaki region, the unemployment rate was much lower at 4.8 percent, with a participation rate of 70.5 percent.

To put this into context, the New Zealand unemployment rate at the time was 7.1 percent and the participation rate was 67.0.

A project of the magnitude of the TTR iron sands would be expected to generate a noticeable increase in economic activity in the South Taranaki and Whanganui economies. Similarly, at the Taranaki region level, the iron sands project would have an impact on economic activity as well as the viability and the resilience of a number of businesses that it would engage with.



TTR'S PROPOSED IRON SANDS PROJECT

TTR is a New Zealand company, established in 2007 to explore and develop the North Island's offshore iron sand deposits. TTR is headquartered in Wellington and is funded by New Zealand and international investment. TTR is keen to build offshore iron ore extraction into a new resource industry for New Zealand. TTR's mission is to develop a world class, profitable and responsible iron sands export company.

Iron sand

Iron sand is magnetic iron ore that originated as crystals in the volcanic rocks of western Taranaki and the Taupo Volcanic Zone. The iron sand was transported to the coast by rivers, and then along the coast by currents, waves and wind settling in dunes. These dunes were covered by rising sea levels at the last marine transgression and became part of the seabed. The regular agitation of the sea over thousands of years by waves and currents has reworked the seabed to an expansive, relatively flat and featureless sandy seafloor.

Iron ore concentrate is produced when separated from the iron sands. It principally comprises magnetite, titanium oxide and vanadium oxide, each of which have commercial uses. These concentrates will be exported to global markets.

Activity

TTR has a 20 year Mining Permit granting exclusive mineral rights to approximately 66km² of the South Taranaki Bight (Figure 5).

TTR proposes to extract up to 50 million tonnes of iron-rich sediment from the seabed each year. The sediment will be processed aboard an Integrated Mining Vessel (IMV). From that, around 5

Figure 5: Map of the iron sands project permit area

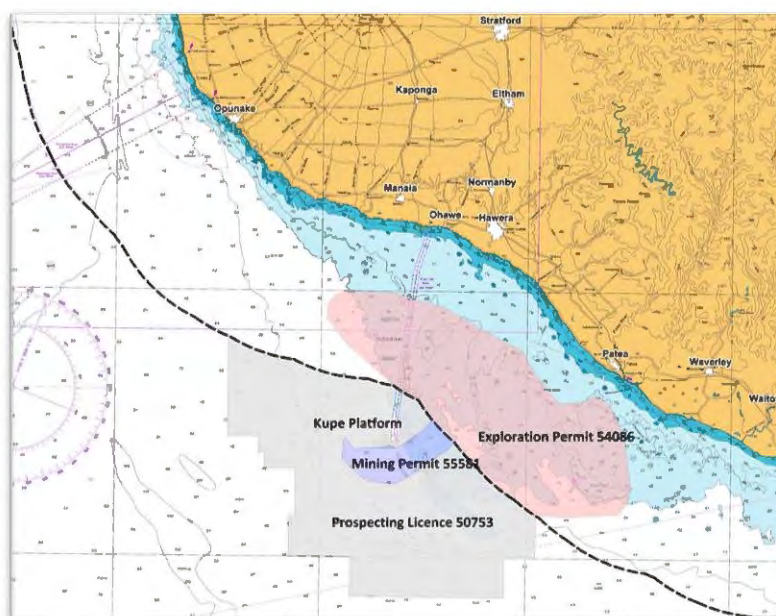

Source: Trans-Tasman Resources Ltd



million tonnes of iron ore concentrate (about 10 percent of the extracted material) will be collected. The remaining sediment (45 million tonnes annually) will be re-deposited on the seafloor in a controlled manner, usually backfilling previously extracted areas. The iron ore concentrate from the IMV will be slurried to a transshipment vessel where it will be de-watered and stored ready for transfer to bulk carrier vessels for export to world markets. This entire process occurs in a single, controlled pass over each mining block.

The project will directly require over 200 people to operate the offshore vessels, with a further 50 staff required in support, engineering, administration, environmental and other contracting roles. The activity is expected to continue for 20 years.

The project will also purchase services from a number of other independent businesses. Many of these services can be delivered from within the study area. This includes fuel bunkering, environmental monitoring, repairs and maintenance, health and insurance, and business services.

It is understood that TTR has undertaken to work with the local community to encourage local engagement and participation on the project. This includes both in the delivery of support services, but also in encouraging local employment directly on the project as well as industry training.

Operating activities

Although the activity occurs more than 20 kilometres off the coast there will be onshore operations associated with the project, with as much activity run out of South Taranaki, Whanganui and New Plymouth as reasonably and financially feasible. The majority of employment will be in providing support to the offshore operations.

The project's mining operations are centred on an IMV that contains the extraction, processing and tailings deposition mechanisms and a single Floating Storage and Offloading vessel (FSO) that will transfer the process concentrate from the IMV onto standard commercial bulk cape-size vessels for delivery to end users.

These large vessels will be supported by a mid-sized Anchor Handling Tug (AHT) that will assist with the provisioning of the vessels, transfer of equipment, and the connection of floating hoses during the concentrate transfer from the IMV to FSO, the berthing of the FSO to the conventional bulk cargo vessels⁵, and anchor and mooring relocation. The AHT will also provide refuelling assistance and be

Environmental impacts

The initial extraction activity will occur more than 22 kilometres off the coast of Patea in water depths of 20 to 45 metres and within an area of approximately 66 square kilometres.

There are no marine reserves or marine mammal sanctuaries in this area, and very few reefs. The seabed lies in an area of constantly shifting sands, so is largely featureless with no rare or vulnerable ecosystems.

Processing on the integrated mining vessel involves separation of the ore from the seabed material using gravity and magnetic processes, and does not involve the addition of any chemicals or other products. The extraction and processing method have been refined to minimise the potential environmental effects of the operations.

⁵ The conventional bulk cargo vessels will be contracted by TTR and will not generate any employment in New Zealand.



equipped to assist in case of any fuel spillage and fire. A Geotechnical Survey Vessel (GSV) will undertake testing and monitoring activity for the project.

IMV and FSO

The IMV and FSO will be “on-station” 24/7 so therefore both vessels will be provisioned, refuelled and maintained while at sea. The crew and, where needed, ad-hoc maintenance staff, of both the IMV and FSO, will be transferred via helicopter from a proposed base in South Taranaki, while provisions and equipment will be transferred by the AHT out of New Plymouth.

Permanent manning requirements of the IMV and the FSO are 122 and 51 people respectively. This allows for two rotations and includes an allowance for relief during holiday periods. These people would be employed directly by TTR.

The equipment on board both these vessels has been designed to be modular in nature, enabling equipment to be transferred via the AHT to a contracted engineering facility in New Plymouth where major repairs or servicing will take place. It is envisaged that smaller repairs and emergency supplies would be sourced within the South Taranaki region and supplied to the operational vessels via helicopter or available vessel.

Servicing activity, including maintenance and repairs, would be contracted out to a third party supplier.

AHT

The AHT will be scheduled to return to New Plymouth periodically to refuel, change crew, collect provisions and, when required, maintain equipment.

The AHT operations will require 36 people. This allows for two rotations and includes an allowance for relief during holiday periods. These people would be employed directly by TTR.

GSV

The GSV will be based out of a proposed geotechnical base in Whanganui. It is envisaged that this vessel will sail on specific planned objectives and will be independent from the ongoing mining operation. It will be crewed, provisioned and supported from its base in Whanganui. The economic impact from the servicing vessel is included in the analysis through estimated expenditure on geotechnical services. The 17 people required to support these activities would be employed directly by TTR.

TTR Corporate Support

A further 35 people will be employed in corporate roles within TTR. All of these roles will be New Zealand based. About three-quarters of these will be based outside of the Taranaki region while about 10 percent will be based in South Taranaki. These ratios are estimates only and can change. For example, there is a chance that a larger portion of the corporate function could be based in New Plymouth.

Bunkering

The iron sands project has a high HFO component with an annual spend of close to \$30 million. This fuel will be sourced in New Zealand through companies who import and refine or bunker fuel in New Zealand. The HFO demand is currently rather limited in New Zealand and is supplied out of Auckland.



However, there are a number of constraints that mean the iron sands project's demand for HFO requires a bespoke solution.

There is potential for the HFO to be supplied from the New Zealand Marsden Point refinery, with the supply being topped up during the summer (cruise season) by supply through either Singapore or Australia. This would result in increased economic activity out of Marsden Point in terms of processing and then storing that fuel. A third party supplier would then be contracted to transfer the HFO to the iron sands project as required. This would be through purchasing HFO from the Marsden Point refinery or offshore and then either shipping directly to the iron sands vessels, or bunkering the HFO in New Plymouth or Wellington and then transferring from there to the iron sands vessels.

The supply of HFO will be provided by a third party. The economic impact would be captured by inputting the expenditure on HFO fuel into the relevant industry multipliers. The economic impact analysis is based on a bunkering facility in New Plymouth, which would directly employ six people.

Potential initiatives to encourage local activity

The following initiatives are being explored by TTR to encourage local activity. However, these are currently exploratory and so haven't been included in the economic impact analysis.

Heli-port

Currently it is expected that helicopter support would be provided out of New Plymouth. However, there is potential, with support from other users in the area, to base a helipad in South Taranaki to service activity off the South Taranaki coast. If this were to happen it would mean additional activity and jobs in the South Taranaki/Whanganui district, as well as reducing travel time and cost to the project. TTR is exploring the possibility and business case for basing a heli-port in Hawera.

A heli-port based in Hawera would employ about six people and have annual operating costs of about \$750,000. Operators (helicopter companies) would be encouraged to employ local people. As the initiative is still being explored, the economic impact analysis currently has this activity being serviced out of New Plymouth.

A potential catalyst for new activity

High demand for HFO fuel by the iron sands project could act as a catalyst for developing a dedicated HFO bunkering facility – something that New Zealand lacks outside of Auckland. A possible location could be Wellington. With other potential users based in Wellington there is strong justification for investment into such a facility. This would involve the construction of a HFO bunker farm tank and the purchase of a dedicated bunker barge, an estimated total investment of close to \$50 million. Such an operation could result in up to 14 new direct jobs.

The potential to capture further business would be from other vessels travelling through the Cook Strait as well as vessels, such as cruise and container ships, calling into Wellington. While these ships are taking on fuel, other vessel support activity is likely to ensue such as provedoring, crew changes etc. This will all create additional activity, not directly related to the iron sands project, but catalysed by it.



Operator and trade training facility

TTR recognises the benefits from ensuring local people are employed in the operation. Possibly even more important is ensuring local people benefit from training, as this is an investment that will benefit the individuals, the community, and ultimately the project itself.

TTR is exploring with businesses and Industry Training Providers (ITP) the potential to develop an operator and trade training facility in the South Taranaki district, in Hawera or Patea. This facility will provide, amongst other skills, Marine Certification qualifications, which are a prerequisite for people to work on the iron sands project. It could also deliver engineering qualifications.

Early discussions suggest that the operator and trade training facility could employ about 11 people with operating costs of about \$1.1 million annually. About 40 trainees would gain qualifications through the facility each year. As this project is still in the discussion phase it has not been included in the analysis.

TTR direct employment

As part of its business planning, TTR has estimated the direct employment for its operations.

The delivery of specialist geotechnical and environmental monitoring services will be provided by the crew of a relatively small support vessel (20m).

Table 5 sets out the employees that will be directly employed by TTR as well as the required level of experience and skills required.

Table 5: TTR personnel

Level	Experience	Number of jobs
Grade 1	15+ years	11
Grade 2	10+ years	19
Grade 3	10+ years, Technical Degree/Diploma,	22
Grade 4	10+ years, Trade/Technical Qualification,	107
Grade 5	5+ years, Trade Qualification,	17
Grade 6	2+ years,	51
Total, Marine Personnel		227
Corporate Positions		35

Source: TTR

The necessary level of experience and skills required for the project are broken down into six grades. It is highly unlikely that grade 1 or 2 people are available in New Zealand. These jobs will need to be filled from offshore. The opportunity to hire from New Zealand and from within the region or locally increases for lower grade roles.



Local employment is expected to increase over time as participation in the project and training programmes continue. Initially, opportunities will be in the lower grade occupations, but will move up over time as local employees gain experience and skills.

As we are aware of these direct employment allocations we have over-ridden the direct employment calculation in the model and inputted these figures directly. Indirect and induced impacts are then calculated using the Regional I-O Multiplier Analysis model.

TTR direct expenditure

Based on the project budget there will be an annual spend of approximately \$254 million, of which a portion will be spent in New Zealand. Of this portion, some will be spent directly in the local area, some will be spent in the region area, and the rest will be spent outside of the Taranaki/Whanganui region. This expenditure is broken down by industry grouping and the geographic area where it is likely to occur in Table 6.

Table 6: Operational expenditure by industry, annual average

Industry	Expenditure (\$m)		
	South Taranaki/Whanganui	Taranaki/Whanganui	New Zealand
Fabricated metal product manufacturing	21.3	21.3	21.3
Exploration and other mining support services	7.6	17.2	34.4
Scientific, architectural and engineering services	3.7	15.8	15.8
Other transport	2.0	10.4	10.4
Basic material w wholesaling	0.0	6.5	32.6
Legal and accounting services	0.0	2.1	14.2
Health and general insurance	0.0	0.0	3.9
Total	34.6	73.4	132.7

Source: MartinJenkins

Of the estimated \$254 million in annual spend, just over half (52.2 percent) is expected to be in New Zealand. Of this \$73.4 million is expected to be spent in the Taranaki/Whanganui region, with just under half of this again (\$34.6 million) spent within South Taranaki/Whanganui.

Expenditure is spread across seven industry groups in New Zealand. For Taranaki/Whanganui it is spread across six industry groups, and within South Taranaki/Whanganui, expenditure is concentrated in four industries.

Looking at the total New Zealand spend, the two main sectors where expenditure occurs are exploration and other mining support services, and basic material wholesaling. A total of \$34.4 million is spent in the exploration and other mining support services sector, which is mainly third party provision of services to the offshore mining vessel. Expenditure of \$32.6 million in the basic material wholesaling sector is made up solely of the purchase of HFO for operating the vessels. This is followed by fabricated metal product manufacturing sector expenditure (\$21.3 million), which is for



repair and maintenance work on the vessels. Other technical support services related to the activity will add another \$15.8 million to costs and is categorised as scientific, architectural and engineering services. Corporate expenditure in New Zealand, which we have classified as legal and accounting services is at \$14.2 million. A further, \$10.4 million is to be spent on direct labour costs related to the mining vessel and is classified as other transport. Finally, there are annual insurance costs of \$3.9 million.

Of the annual expenditure in New Zealand, 26 percent will be spent directly with businesses in the South Taranaki and Whanganui districts. All of the expenditure in fabricated metal product manufacturing (\$21.3 million) will be initially spent in South Taranaki or Whanganui. About \$7.6 million will be spent in the exploration and other mining services sector and \$3.7 million will be initially spent in South Taranaki and Whanganui in the scientific, architectural and engineering services sector. Finally about \$2 million will be spent in South Taranaki/Whanganui to support the geotechnical servicing role, which is categorised in the scientific, architectural and engineering services sector.

The Taranaki/Whanganui region captures approximately 55 percent of the project's total New Zealand expenditure annually, or \$73.4 million. The region accounts for 100 percent of activity in three industries - fabricated metal product manufacturing, scientific, architectural and engineering services industries, and other transport. It also captures half of the New Zealand expenditure in the exploration and other mining support services industry and about 20 percent of activity in the basic material wholesaling industry (\$6.5 million). Finally, the region captures 15 percent of the activity in legal and accounting services.



ECONOMIC IMPACT ANALYSIS

Economic impact analysis (EIA) shows the additional impact to economic activity (gross output, GDP and employment) directly attributable to an event or action, in this case the iron sands project. The EIA has been calculated for three study areas – local (South Taranaki and Whanganui districts), regional (the Taranaki region and Whanganui district), and New Zealand. The three sets of economic outcomes are not additive. That is, the New Zealand impact includes the regional impact, which includes the local impact.

The EIA does not include the impact from taxes and royalties collected by the government. Nor does it consider the additional economic benefits to the country from increased exports. These are quantified and discussed separately.

Local (South Taranaki/Whanganui)

The iron sands project is expected to generate about \$18.6 million in GDP and employ 299 people in the South Taranaki/Whanganui economy each year over 20 years.

About \$34.6 million is expected to be spent directly on activities and businesses based in South Taranaki/Whanganui each year. The impact of this direct spend is estimated to generate \$13.6 million in GDP and direct employment of 173 people. The direct, indirect and induced impacts of the iron sands project on the South Taranaki and Whanganui districts is presented in Table 7.

Table 7: Economic impact of activity on the South Taranaki district

South Taranaki/ Whanganui	Direct	Direct + Indirect	Direct + Indirect + Induced
Output (\$m)	34.6	41.2	45.1
GDP (\$m)	13.6	16.3	18.6
Employment (FTEs)	173	256	299

Source: MartinJenkins

Including indirect and induced impacts, the initial direct expenditure of \$34.6 million is estimated to contribute \$18.6 million to the South Taranaki and Whanganui economy and employ 299 people annually.

To put this into context, the South Taranaki/Whanganui economy has an estimated GDP of \$3.5 billion and employs about 32,400 people. The TTR iron sands project would increase GDP by half of a percent and employment by close to one percent.



Regional (Taranaki/Whanganui)

The iron sands project is expected to generate about \$50.6 million in GDP and employ 683 people in the Taranaki/Whanganui economy each year over 20 years.

The business plan suggests that \$73.4 million is expected to be spent directly on activities and businesses based in the Taranaki/Whanganui region each year. The economic impact of this direct spend is estimated to be \$30.4 million in GDP and direct employment of 367 people. The direct, indirect and induced impacts of the iron sands project on the Taranaki/Whanganui region is presented in Table 8.

Table 8: Economic impact of activity on the Taranaki/Whanganui region

Taranaki/ Whanganui	Direct	Direct + Indirect	Direct + Indirect + Induced
Output (\$m)	73.4	100.5	115.7
GDP (\$m)	30.4	41.9	50.6
Employment (FTEs)	367	585	705

Source: MartinJenkins

Including indirect and induced impacts, the initial direct expenditure of \$73.4 million is estimated to contribute GDP of \$50.6 million to the Taranaki/Whanganui economy and employ 705 people annually.

To put this into context, the Taranaki/Whanganui economy has an estimated GDP of \$10 billion and employs about 75,300 people. The TTR iron sands project would have a similar impact as in South Taranaki/Whanganui, increasing GDP by half of a percent and employment by almost one percent.



New Zealand

The iron sands project is expected to generate about \$159 million in GDP and employ 1,666 people in the New Zealand economy each year over 20 years.

About \$132.7 million is expected to be spent directly on activities and businesses in New Zealand each year. The impact of this direct spend is estimated to be \$59 million in GDP and direct employment of 453 people. The direct, indirect and induced impacts of the iron sands project on the New Zealand economy is presented in Table 9.

Table 9: Economic impact of activity on New Zealand

New Zealand	Direct	Direct + Indirect	Direct + Indirect + Induced
Output (\$m)	132.7	254.2	349.1
GDP (\$m)	59.0	111.1	159.0
Employment (FTEs)	463	1,146	1,666

Source: MartinJenkins

Including indirect and induced impacts, the initial direct expenditure of \$132.7 million is estimated to contribute \$159 million to the New Zealand economy and employ 1,666 people annually.

To put this into context, the New Zealand economy has an estimated GDP of \$224.6 billion and employs about 2.2 million people. The TTR iron sands project would have a smaller impact than in Taranaki/Whanganui increasing GDP by seven-tenths of one percent and employment by less than one-tenth of one percent.



Other quantitative impacts

The economic impact analysis only considers the GDP and employment generated from the operational expenditure of the project. The project is also expected to contribute royalties and taxes to the New Zealand government. This revenue will likely be spent generating further employment and GDP.

As well, the iron ore produced by TTR will be exported. This will generate export earnings, which is a key growth goal for New Zealand.

The estimated minimum royalty payment to New Zealand each year is about \$6.15 million, and the project would contribute about \$312 million to New Zealand exports.

Royalties and Taxation

Based on the assumptions at the time of this report the estimated minimum royalty is expected to be around US\$4 million or \$6.15 million annually.

To put this into context, petroleum, minerals and coal royalties in 2015 were about \$285 million of which minerals accounted for \$6 million (2 percent). Minerals and coal royalties were not expected to increase in 2016, while petroleum royalties were expected to decline by about 20 percent.⁶

The iron sands project would more than double the annual contribution from minerals to \$12.15 million and increase minerals' contribution to royalties to about 5 percent.

Price rises in iron ore will lead to greater royalties and taxes. Income Tax and Accounting Profits Royalty are dependent on profitability, which cannot be estimated at this time, as the final project cost and capital structure are unknown. These affect the deductible items of depreciation, amortisation and interest. In general Figure 6 illustrates the relationship.

Figure 6: Royalties and taxes

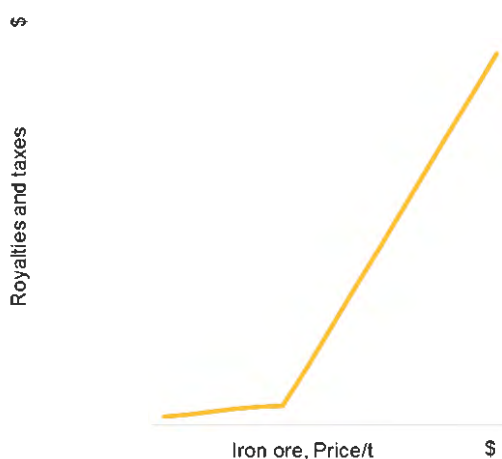

Source: MartinJenkins

⁶ (The Treasury, 2015)



Royalties provide a constant revenue stream to government, which also benefits from the upside of profitable operations. As the sales revenue from the iron ore increases with price, the royalties paid increases. Further, as the project moves into profitability, the amount of tax paid increases. At a certain level of profitability, royalties move from a proportion of sales revenue to a proportion of accounting profits.⁷

TTR will also have other statutory and regulatory compliance costs including ACC levies, Kiwisaver contributions, and applicable taxes such as Income Tax, Non Resident Withholding Tax, Fringe Benefit Tax, etc.

Royalties and company income tax are not tied to a certain expenditure area but are put into general crown revenue where they contribute to the delivery of the full range of government services that benefit New Zealand. There is significant upside to government revenue from an upswing in iron ore prices and the resulting profitability of the project.

Exports

Based on the pricing assumptions as outlined in this report, iron ore exports are expected to exceed approximately US\$200 million (\$312 million) annually.

Iron ore exports of \$312 million would put it into the top 20 of items exported from New Zealand. Combined with iron and steel and articles of iron and steel, the category would have exports of close to \$1 billion.

The New Zealand Government has set a Business Growth Agenda (BGA) target of increasing exports to 40 percent of GDP by 2025. Step-change increases in exports such as from the iron sands project, will go some way toward achieving that target.

⁷ The New Zealand royalty regime stipulates the payment of the higher of a 5 percent ad valorem royalty or a 20 percent accounting profits royalty.



Table 10: New Zealand's principal exports, year to June 2015

Export category	\$m
Dairy	12,036
Meat	6,376
Wood	4,596
Wine	1,424
Seafood	1,407
Machinery and Mechanical Appliances	1,353
Oil	1,215
Methanol	c...
Kiwifruit	1,182
Aluminium	1,071
Electrical Machinery and Equipment	808
Wool	805
Precious Stones, Metals and Jewellery	688
Iron and Steel and Articles of Iron and Steel	638
Apples	562
Plastic Materials and Articles of Plastic	452
Vegetables	395
Live Animals	370
Iron Ore	312
Carpets and other Textile Floor Coverings	128
Fabrics, Textiles and Apparel	125
Printed Books, Newspapers etc	53

Source: Statistics New Zealand

Exports in 2015 (year to June) were about \$46 billion. Iron sands exports at \$312 million, are about 0.7 percent of total merchandise exports. However, on its own it would still be one of the top 20 items exported, with a greater contribution than carpets and fabrics, textiles and apparel.

Including iron sands exports into the iron and steel and articles of iron and steel category, then the industry would have exports of close to \$1 billion, about two percent of total exports.

Note that the \$312 million in exports is at a net received iron ore price of US\$40/t. If the net received price of iron ore were to recover to about US\$60/t, iron ore exports would move up even further to 16th, and when grouped with iron and steel and articles of iron and steel, into the top 10.



QUALITATIVE IMPACTS

As well as the quantitative impacts in terms of GDP, employment, government revenue there are several qualitative benefits from the iron sands project on the study areas.

Complementarity and diversification

Complementarity

The Taranaki region has well developed oil and gas, dairy and engineering sectors. The Taranaki region is New Zealand's only oil and gas producing region and has a comparative advantage in that sector. Each year, the oil and gas sector contributes about \$1.6 billion to the Taranaki region economy and employs about 7,000 people in the Taranaki region.⁸

As oil and gas and dairy activity has grown, businesses, particularly in the structural and mechanical engineering sectors, have adapted and developed their capability to provide support services to both sectors. Offshore mining for iron ore will complement the existing oil and gas sector. In particular, the range of support services for offshore mining will be very similar to those used for the oil and gas industry. This means that the infrastructure and services are already in place and the sector does not have to start from scratch or import all of its services.

For businesses and job seekers in the industry, this has a positive impact as it provides another source of demand for their services and skills. In some cases, the presence of the iron sands project could also make certain businesses or services more viable or sustainable.

For the Taranaki region, which considers itself to be the energy capital of New Zealand, the iron sands project will further add to its reputation and help build its capability to support natural resource extraction industries.

Diversification

Countries, and indeed regions, are continually trying to diversify their economies so that they are not overly reliant on any one industry. Industry diversification is often an economic development objective for economic development agencies or even national agencies.

The study areas (South Taranaki/Whanganui and Taranaki/Whanganui) both have a strong dependence upon the dairy sector and the oil and gas sector.

Although iron ore is a commodity and there is some correlation of prices with oil and gas, it does provide some diversification within the Taranaki region. Having diversification within the extraction industries will contribute increased economic resilience to shocks.

⁸ (Venture Taranaki, 2015, p. 3)



Local development

The main area of activity is likely to be in South Taranaki and Whanganui. This is a relatively small economy in a rural area where the effects of a project will have a noticeable impact on the local economy, particularly as new jobs are generated. While there is oil and gas and extraction activity in South Taranaki, much of this is serviced out of New Plymouth, limiting the benefits to the local region.

It is understood that TTR is looking to have as much positive impact on the local area as it possibly can. This includes establishing support functions in the rural area (rather than basing it in New Plymouth), utilising local services where possible (ie engineering services), and working with the community to encourage participation from the local workforce.

TTR has advised that it envisages that, at project initiation, approximately 30 percent of all TTR employed persons would be New Zealand citizens with approximately 10 percent of those being from local South Taranaki and Whanganui communities. It is TTR's aspiration that after five years of operation, sufficient technology and skills transfer has taken place that 80 percent of the people employed directly will be New Zealand citizens, and that a significant proportion of those would be from South Taranaki/Whanganui communities.

To achieve this, TTR is exploring the possibility of basing a training school in South Taranaki, working with an ITP and regional businesses to assess the viability.

Long term, main contractors and service suppliers will also be required to ensure a progressively increasing local quota with regards to people employed within their organisation working on the TTR operation. These contractors and service suppliers will also be required to include local firms on tender lists.

The GSV would be based out of Whanganui harbour, providing much needed activity in the local area. As mentioned on page 17, there is potential to develop a heli-pad in Hawera or Opunake, which would provide services to offshore activity.

Investing in training and employment of local people will benefit the individuals, the community, the region and, ultimately, the project itself.



POTENTIAL NEGATIVE IMPACTS

It has been argued that the iron sands project could have detrimental effects on other industries or activity in the district/region, in particular tourism and fishing (commercial and recreational).

The initial extraction activity will occur in an area of approximately 66 square kilometres in the Taranaki Bight, more than 22 kilometres off the coast of Patea. About 5 square kilometres would be worked on each year, a total of 0.3 percent of the entire Bight. Mining will be in water depths of 20 to 45 metres. There are no marine reserves or marine mammal sanctuaries in this area, and very few reefs.

An independent assessment of the ecological effects from the project (NIWA, 2014) stated that

‘for all zooplankton, seabird, and marine mammal species, and most fish species, there should be negligible effects of mining 50 million tonnes per annum according to standard evaluation criteria. This is principally because the scale of the mined area and the areas of elevated suspended sediment concentrations are small compared to the area used by the populations of these species. Consequently they are likely to be displaced from, or experience a decrease in prey abundance or availability over a very small part of their distribution. For coastal kaimoana species, the proposed mining activity should not add significantly to the levels of suspended sediments currently experienced inshore in frequently turbid waters.’

Notwithstanding this assessment, a description of the scale of these industries is provided for context.

Visitors

Visitor expenditure in Taranaki has increased markedly in 2014, consistent with the sector’s performance at a national level.

In the year ending March 2014, it is estimated that visitors to the South Taranaki/Whanganui area spent \$126 million. Visitor expenditure has been growing by 0.7 percent annually. However, this has been driven by Whanganui, with South Taranaki seeing a decline of -0.7 percent annually.

Table 11: Visitor expenditure, 2009 - 2014

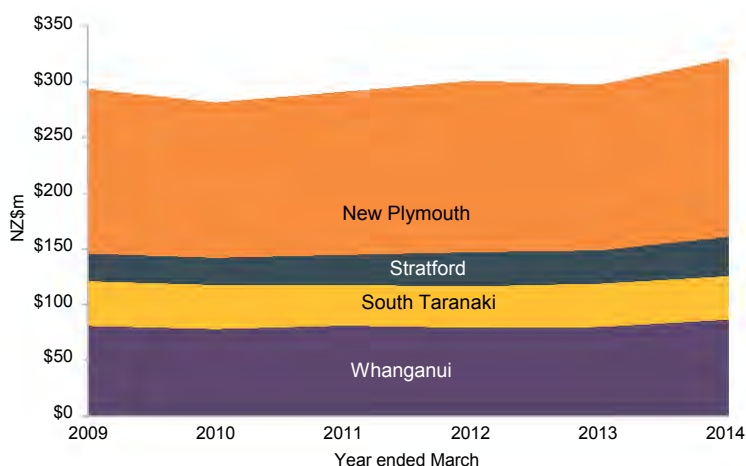

Source: (Ministry for Business Innovation and Employment, 2015)



At the Taranaki/Whanganui regional level, visitor expenditure in the year ending March 2014 was \$321 million. For the Taranaki/Whanganui region, visitor expenditure increased from a low in 2010 of \$281 million. The South Taranaki and Whanganui districts account for about 39 percent of the region's visitor spend.⁹

Most visitor activity is onshore. As the site is not easily visible from the shore, the impacts on tourism from any environmental effects would be minimal. In fact, one could argue that there could actually be a small increase in visitor numbers due to the increased activity because of the project, in particular, relatives of employees and business travellers, possibly including their families too.

Commercial fishing

There were no people employed in fishing and aquaculture in the South Taranaki district in 2014 and two people employed in seafood processing. Whanganui had seven people employed in fishing and aquaculture and two employed in seafood processing.

In the Taranaki region, a further 26 people were employed in fishing and aquaculture. Egmont Seafoods Limited, based in New Plymouth, is the only fishing company/seafood processor in the region, and directly employs 16 full-time staff.

Applying the output to FTE ratios in the multiplier tables suggests that commercial fishing generated expenditure of about \$2.3 million in South Taranaki/Whanganui and about \$26.5 million in the Taranaki/Whanganui region.¹⁰ This suggests total contribution to GDP of \$700,000 in South Taranaki/Whanganui and \$8.2 million in Taranaki/Whanganui.

We note from TTR's 2013 marine consent application that the Ministry for Primary Industries (MPI) submission and expert evidence of Dr Gibbs (April 2014) agree that there is unlikely to be any negative impact on the commercial fishing industry.¹¹

Recreational fishing

The value of recreational fishing is only relevant if there is a counterfactual of no fishing. At one end of the spectrum, the loss of small areas to fishing may simply mean effort is transferred to other locations. If there were any impacts from the iron sand project, it would be isolated and concentrated in a small area where limited fishing occurs anyway. Therefore, taking the argument that affected fishermen would simply fish elsewhere, the economic cost to recreational fishing is likely to be minimal.

For the sake of analysis, any cost to recreational fishers would therefore be based on the unsupported assumption that the iron sands project means that some or all existing recreational fishers can no longer fish at all.

⁹ (Ministry for Business Innovation and Employment, 2015).

¹⁰ Business demography statistics and national accounts for GDP estimates by industry.

¹¹ (Ministry for Primary Industries, 2013), (Gibbs, 2014).



A range of studies have put the indicative annual value of recreational fishing per fisher at \$130 to \$2,000. The two New Zealand studies in that range (Schischka & Marsh, 2008), (Kerr, Hughey, & Cullen, 2003) put the value at \$495 and \$130 per fisher annually.

The number of recreational fishers in the South Taranaki/Whanganui area is unknown. Studies of fishing participation in New Zealand put the participation rate at between 9.7 percent and 39 percent. Applying the participation rates to the South Taranaki/Whanganui population using the New Zealand estimated annual value of recreational fishing and applying a hypothetical chance that one percent of fishers were no longer able to fish suggests a value in a wide range from \$8,900 to \$137,000.

Another separate approach (Kerr & Latham, 2011) valuing the fish caught by recreational fishermen puts the commercial value for recreationally harvested species at about \$180 million annually. With South Taranaki/Whanganui accounting for about 1.6 percent of the New Zealand population and assuming they account for a consistent share of recreational fishing, suggests a value of recreational fishing to the South Taranaki/Whanganui area of \$2.9 million.¹²

An online search for fishing charter businesses in South Taranaki and Whanganui identified two operators operating in South Taranaki - South Taranaki Fishing Charters out of Patea and Hy-jinks Charters out of Eltham; and one operating out of Whanganui – Fluffy Duck Charters. A further four charters companies were identified operating out of New Plymouth but they would be unlikely to be materially affected. TTR has chartered vessels from the local area in the past to assist in their operations, so anecdotally there could be an increase in demand for their services.

We note from TTR's 2013 marine consent application that the MPI submission states the impact on recreational fishing is likely to be negligible or non-existent.¹³

Summary of economic costs

Taking the maximum estimate for each of these areas (visitors, commercial fishing and recreational fishing) suggests a total value (gross output) of \$142 million for South Taranaki/Whanganui and \$369 million for Taranaki/Whanganui.

Taking a risk approach and assuming, for example, that there was a 1 percent chance of negative impacts from the iron sands project and that the impact would result in, also for example, a 10 percent decline in activity in each of those industries would put the costs of negative impacts at \$142,000 for South Taranaki/Whanganui and \$369,000 for Taranaki/Whanganui. This is well below the expected direct gross output from the direct activity in South Taranaki/Whanganui (\$34.6 million) and Taranaki/Whanganui (\$73.4 million).

We would note that the one percent likelihood and share of industry impacted used in this example is high and the example is just to illustrate costs. The nature and location of the iron sand activity and ecological reports undertaken for this project suggest the likelihood of negative impacts on zooplankton, seabird, and marine mammal species, and most fish species would be negligible.

¹² This analysis is only applied at the South Taranaki/Whanganui area level as it is not likely that New Plymouth or Stratford recreational fishers would be affected.

¹³ (Ministry for Primary Industries, 2013)



REFERENCES

- Els, F. (2015, April 29). *www.mining.com*. Retrieved from Mining.com: www.mining.com/iron-ore-price-rally-turns-into-dead-cat-bounce/
- Gibbs, N. (2014). Statement of Summary Evidence of Nici Gibbs on behalf of Trans-Tasman Resources Ltd. Wellington.
- International prices of imported raw materials - Iron ore - Chinese imports, Tianjin Port - Spot price - CIF - 62% Fe type - Price in US dollars per tonne*. (2015, September 9). Retrieved from National Institute of Statistics and Economic Studies: <http://www.bdm.insee.fr/bdm2/affichageSeries?idbank=000455735&codeGroupe=298>
- Kerr, G. N., Hughey, K. F., & Cullen, R. (2003). *Marine Recreational Fishing: Perceptions and Contingent Behaviour*. Commerce Division Discussion Paper No. 99. Lincoln University.
- Kerr, G., & Latham, N. (2011, August 25-26). The Value of Recreational Inshore Marine Fishing. *Paper Presented at the 2011 NZARES Conference*. Nelson, New Zealand.
- Ministry for Business Innovation and Employment. (2015). *Regional Tourism Estimates*. Wellington: Ministry for Business Innovation and Employment.
- Ministry for Primary Industries. (2013). *Review of impacts on fisheries resulting from application to mine iron sand in South Taranaki Bight*. Wellington: Appendix 1 of the Ministry for Primary Industries submission to Trans-Tasman Resources application to the Environmental Protection Authority.
- NIWA. (2014). *Assessment of the scale of marine ecological effects of seabed mining in the South Taranaki Bight: Zooplankton, fish, kai moana, sea birds and marine mammals*. Wellington: A report prepared for Trans-Tasman Resources Ltd.
- Schischka, T., & Marsh, D. (2008). Shared fisheries: Results from an investigation into the value of the recreational and commercial catch in a New Zealand quota management area. *Paper presented to the Australian Agricultural and Resource Economics Society annual conference*. Canberra, 6-8 February.
- The Treasury. (2015). *Budget Economic and Fiscal Update 2015*. Wellington: New Zealand Treasury.
- Venture Taranaki. (2015). *The Wealth Beneath our Feet*. New Plymouth: Venture Taranaki Trust.
- World Bank. (2015). *World Bank Commodities Price Forecast*. World Bank.



APPENDIX 1: REGIONAL I-O MULTIPLIER ANALYSIS

Underlying logic

The underlying logic of Regional I-O Multiplier Analysis is that enterprises create flows of expenditure (direct impacts) that are magnified or 'multiplied' as they flow on to the wider economy. This happens in two ways:

- 1 indirect impacts - the enterprise purchases materials and services from supplier firms, who in turn make further purchases from their suppliers and so forth
- 2 induced impacts - employees in the enterprises and in firms supplying services are paid a wage and the enterprises generate profits, which is then spent on consumption.

The total impact is then the sum of the direct, indirect and induced impacts.

Multipliers

Regional multipliers are used to capture the indirect and induced impacts at a regional or national level. They are also used to calculate GDP. Multipliers are derived from the I-O tables published by Statistics New Zealand and the local (South Taranaki and Whanganui districts) and the regional (Taranaki region and Whanganui district) I-O tables supplied by Butcher Partners Limited.

The size of the multiplier depends upon the degree of economic self-sufficiency. The more self-sufficient a region or nation is, the higher the multiplier is likely to be. Initial expenditure is assigned to the industry where it occurs. Each industry has a different multiplier based on the average pattern of purchases of goods and services, capital formation, profits, wages and salaries.

Measures of economic activity

An analysis allows for the determination of three measures of economic activity – Gross Output, Value Added and Employment.

Gross Output is the value of production, which is built up through the national accounts as a measure of gross sales or turnover. It is essentially the initial expenditure incurred by the activity.

Value Added is the increase in output generated along the production process, which when aggregated totals GDP. Value Added is the sum of:

- compensation of employees (salaries and wages)
- income from self-employment
- depreciation
- profits and
- indirect taxes less subsidies.



Employment is generally expressed as full-time equivalents (FTEs) to allow for comparison. FTEs is the number of full-time employees and working proprietors. FTEs provide a measure of total labour demand associated with gross output for one year. For example, four full-time jobs running for three months would be shown as one FTE.

Limitations of Regional I-O Multiplier Analysis

There are acknowledged limitations of Regional I-O Multiplier Analysis. However, we consider that the nature of the iron sands project and where the activity is located means that it is not overly affected by the limitations as shown in the following table.

Table 12: Addressing the limitations of regional I-O multiplier analysis

Limitation	Application in this analysis
<p>Additionality and displacement – the I-O multiplier analysis assumes that the activity or event being analysed is new activity and does not displace existing activity.</p>	<p>Additionality and displacement needs to be considered separately before the activity is inputted into the model. Our assessment is that the project is additional and will not displace existing activity.</p> <p>Offshore iron sand extraction is a new industry and is operating in an area where there is currently limited economic activity. As such it is most likely that the entirety of activity is additional.</p> <p>In terms of displacing resources, the project is in a niche area of resource extraction, which attracts sophisticated, niche investors who focus on these types of investments globally. This means it is unlikely to displace investment in other industries.</p> <p>In relation to labour and servicing industries, there is surplus capacity within the region that will be absorbed within existing businesses rather than displace engagement with existing activity.</p>
<p>Static model - It is assumed that an activity will not have an impact on relative prices.</p>	<p>The larger the activity, or the more concentrated it is in a single industry or region, the more likely it is that relative prices would change.</p> <p>A relatively large share of inputs, particularly labour and capital, will initially come from offshore, meaning there is unlikely to be significant impacts on input prices.</p> <p>The product is also globally traded and in insufficient volume to impact on price.</p>
<p>Aggregation and accuracy of multipliers - Each industry has its own unique inputs and outputs and thus multipliers. The more aggregated the level of analysis, the less accurate these inputs and outputs become. It is therefore important to apportion the initial expenditure to the industry where it occurs.</p>	<p>With regards to aggregation limitations impacting on accuracy, TTR expenditure has been broken down into individual expense areas and then allocated to the most relevant industry. The current analysis allocates activity across seven separate industries, which provides a higher level of accuracy.</p> <p>However, we accept that the accuracy is likely to be greater for the larger study areas as spending is quite focused in the South Taranaki district but broadens across a larger number of industries in Taranaki and New Zealand.</p>
<p>Regions and boundaries - The smaller or less defined a region and its boundaries, the less accurate the multiplier analysis will be. Similarly, the easier it is to move across boundaries, the less accurate the analysis will be.</p>	<p>With regards to region and boundary accuracy, the South Taranaki district is a small economy with a high level of leakage. However, much of this leakage will be to New Plymouth due to the isolation of the Taranaki region. The region is also fairly isolated with clear boundaries and distances to other economic regions.</p> <p>As well, the Taranaki region has strong oil and gas and dairy industries, with the supporting service sector also likely to support the iron sands project. This means that activity can be serviced out of New Plymouth.</p> <p>As such the analysis at the Taranaki region level is likely to be more accurate than in, say, a more central region surrounded by other, high activity areas.</p>

